



I-SHEET PART NUMBER: INST-00322
 PART NUMBER: **NBF212B-TX**
 PRODUCT: **NERF BOARD**
 APPLICATION: **21-22 FORD BRONCO 2DR**

HWKT-12136X		QTY
BHCS-09591X	M6X16MM BUTTON HEAD CAP SCREW	12
FW-09601	M6 FLAT WASHER	12
BHCS-09603	M6 flanged nut	12
CARB-09609	3/8"-16X1" Gr 5 Steel Carriage Bolt	8
FLNT-00664	3/8-16 GRADE 8 STEEL FLANGE NUT	8
HWKT-04239X		QTY
M10x25mm hex flanged bolt		8

PARTS INCLUDED	QTY
Driver Side Running Board	1
Passenger Side Running Board	1
Rocker panel brackets	4
Step Plate	2



Step 1: Identify Driver Side Nerf board.

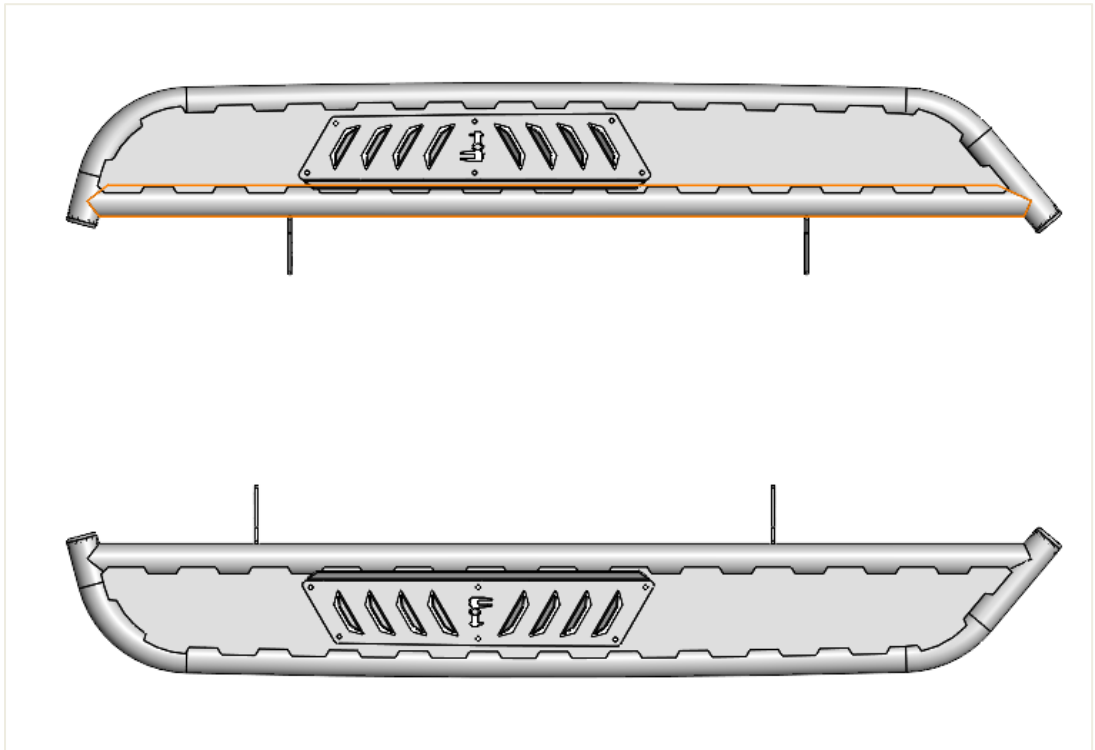

Step 2: Install the supplied step plate (x2) to each Running Board using the M6x20mm button head bolts, M6 nuts and M6 flat washer.

**** DO NOT OVER TIGHTEN ****

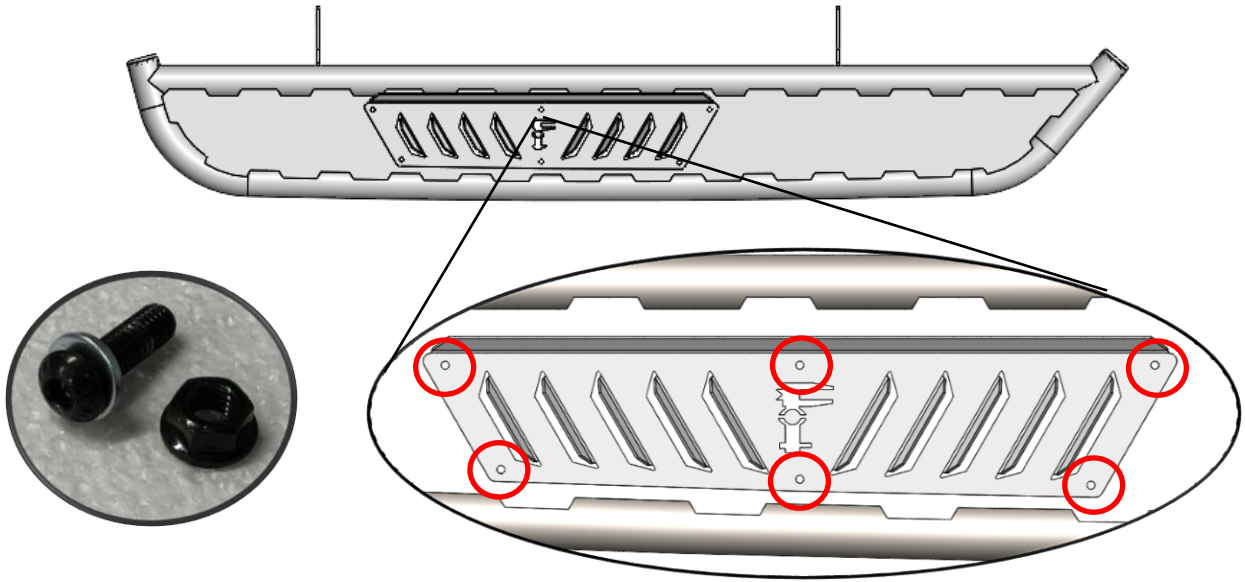

Step 3: Install (x2) mounting brackets to each attachment point with the supplied 3/8" x 1" carriage bolt and flanged 3/8" nut on the main tube. Hand tighten for now. Repeat with passenger side.

NOTE: *Mounting brackets will be attached in the forward position with the threaded part of the carriage bolt facing towards the rear of the vehicle.*

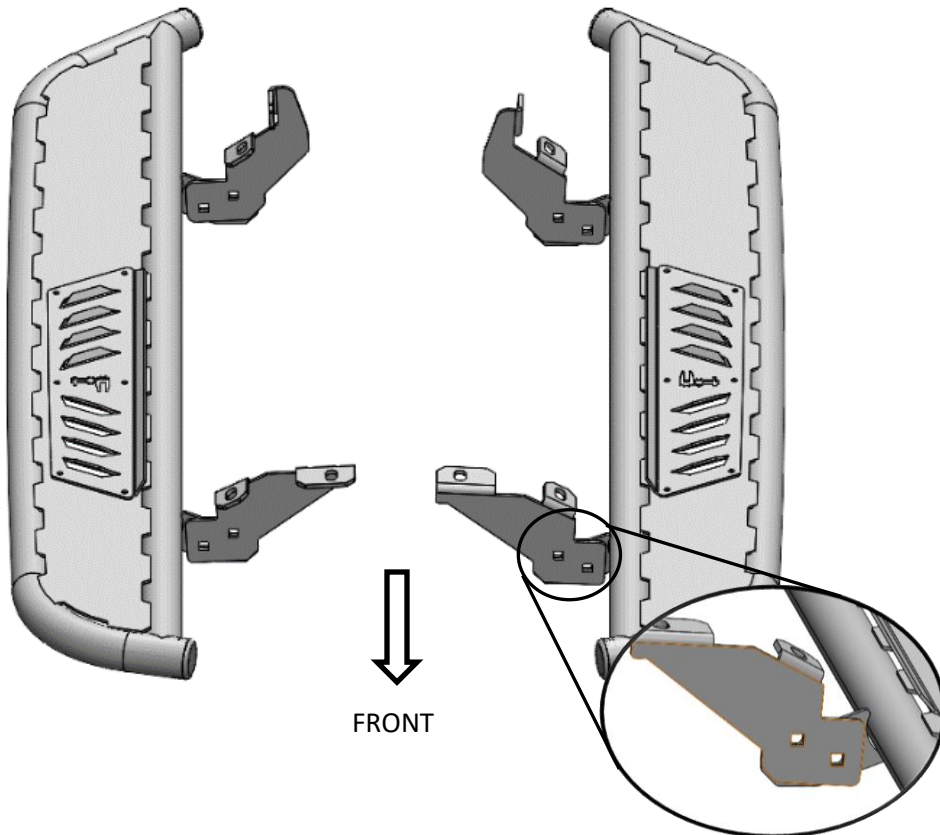



I-SHEET PART NUMBER: INST-00322
PART NUMBER: **NBF212B-TX**
PRODUCT: **NERF BOARD**
APPLICATION: **21-22 FORD BRONCO 2DR**

Step 4: Install Nerf Board assembly to the factory mounting location using the supplied M810 flanged hex bolt (x4). Leave loose for now.



Step 5: There will be $\frac{1}{2}$ " of adjustment in the (x2) mounting bracket. Adjust to desired position and tighten to (20 ft./lbs). Then tighten body mount brackets to (25-30 ft./lbs)

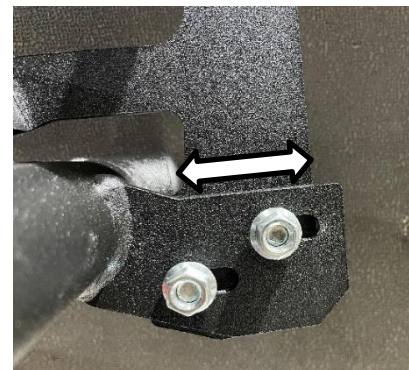

Step 7: Repeat steps 4-5 for the passenger side.