

# REALTRUCK

## INSTALLATION INSTRUCTIONS



### PART NO.

- 20404580T/PC
- 20404587T/PC

### PRODUCT DESCRIPTION:

- VoltStep Electric Running Board

### VEHICLE APPLICATION

- Silverado/ Sierra Crew Cab
- Silverado/ Sierra Extended Cab

## PRODUCT SAFETY & LEGAL DISCLAIMER

- **IMPORTANT READ ALL INSTRUCTIONS CAREFULLY BEFORE INSTALLING. FAILURE TO DO SO MAY CAUSE PERSONAL INJURY OR DAMAGE TO PRODUCT AND/OR PROPERTY.**
- **Review the product package and contents prior to beginning the installation.** Take care when opening the packaging and removing items. If a return is needed you will want to return the product in its original packaging if possible.
- This instruction guide is provided as a GENERAL installation guide, some vehicles vary dimensionally and may require additional steps.
- Test fit the product on the vehicle prior to any third party modifications and or finishing. The manufacturer and/or distributors do not accept responsibility for third party charges, labor and or third part replacement modifications. Some modifications may void the factory warranty.
- Exercise due-diligence when installing this product. The manufacturer and distributors of this product do not accept any responsibility for vehicle damage or personal injury resulting from the installation of this product. Careless installation and operation can result in serious injury or equipment damage.
- This product is for general off-road use. All liability for installation and use rests with the owner/operator.
- **INSTALLER:** Once installation is complete, please return this guide along with other documentation included in this product back to the consumer for future reference. The manufacturer/distributors of this product do not guarantee this particular version will be available at a later date.

© 2024 RealTruck Products. All rights reserved

www.realtruck.com 589 W. Apollo St., Brea, CA 92821 P: 888 427 4466



# INSTALLATION INSTRUCTIONS

## INJURY HAZARD

Please complete a shop and tool inspection prior to beginning the installation.

- Always make sure you have a clean, dry and well lit work area.
- Always remove jewelry, loose fitting clothing and wear protective gloves and eye protection.
- Always use extreme caution when jacking or raising a vehicle for work. Set the emergency brake and use tire/wheel blocks and jack stands. Refer to the vehicle manufacturer hand book. Utilize the vehicle manufacturers designated lifting points.
- Always use appropriate and adequate care in lifting parts during disassembly and installation. Seek help in lifting heavy or large items into place. Utilize jacks and or lifting devices when available.
- Always insure products are secure during disassembly and installation.
- Always wear eye protection and take steps to protect any exposed skin during the installations. Drilling, cutting and grinding plastic and metal may create flying particles that can cause injury.
- Always use extreme caution when drilling, cutting and or grinding on a vehicle. Thoroughly inspect the area to be drilled, on both sides of material, prior to modification and relocate any objects that may become damaged.
- Always assemble and tighten all fasteners per the installation instructions.
- Always route electrical cables carefully. Avoid moving parts, parts that may become hot and rough or sharp edges.
- Always insulate and protect all exposed wiring and electrical connections.

## MAINTENANCE AND CARE

- Always perform regular inspections and maintenance on mounts and related fasteners.
- Periodically check and tighten all fasteners.
- Stripped, fractured, or bent fasteners must be replaced.
- After washing the vehicle make sure to fully dry all surfaces.
- In areas with cold temperatures make sure to wash the product often to remove harmful materials used on road ways.
- Never use abrasive cleaners or polish compounds. Clean with a gentle soap and water. If you use wax use a non-abrasive automotive wax such as pure carnauba wax.

## WARNING

Some products have been designed to work together with factory rear sensor systems, factory forward facing sensor systems and factory air bags.

- Installation of some of these products may alter the factory sensor system performance.
- Factory sensors may read shackles or hooks protruding from the fairlead and or tow hooks.
- All sensor testing is completed by RealTruck Products and or third party testing labs on modified vehicles.
- Sensor sensitivity, factory sensor housing, orientation, and operating conditions are all variables that will influence functionality of the sensors.
- Installation of some product may effect the factory air bag systems.
- Some products allow the use of third party products such as winches, shackles, hooks, etc. Follow the respective manufacturers operating instructions for use with our products.
- Make sure to fully understand the product, it's intended use and operation prior to use.
- Above all... be safe!

# REALTRUCK<sup>®</sup>

## INSTALLATION INSTRUCTIONS

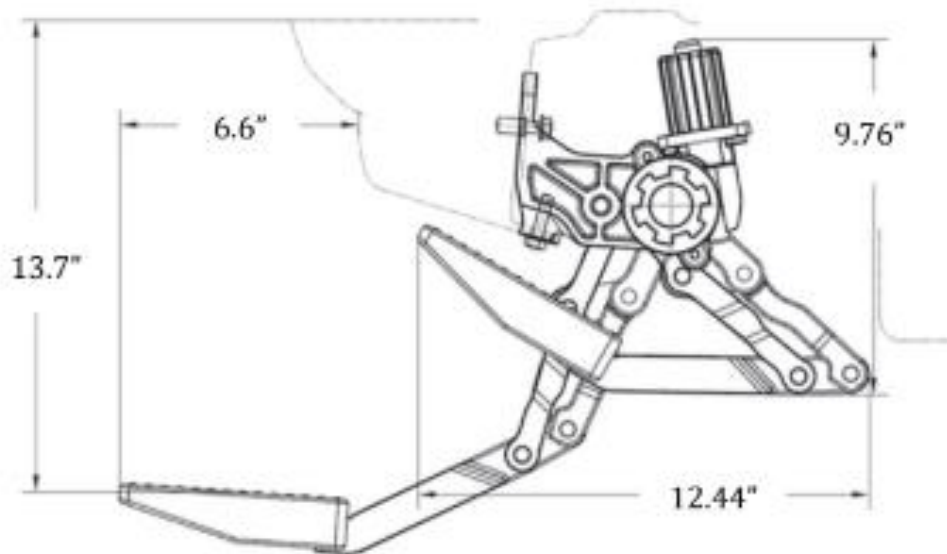

### PRODUCT TECHNICAL SPECIFICATIONS

- Rated Voltage: 12V
- Load Rating: 600 lbs. per side
- Gross Weight: 55 lbs.
- Horizontal Extension: 6.6" (Horizontal distance between the edge of power board and the vehicle door when the board extends)
- Step Height: 13.77" (Vertical height difference between the edge of power board and the vehicle door while board extending.)

**WARNING:** Keep a minimum of 10" safe distance while the RealTruck VoltStep is operating to avoid any personal injury or damage to the running boards. RealTruck VoltSteps are not designed to provide vehicle body protection. Components can be damaged by hard impact or contact with foreign objects.



## INSTALLATION INSTRUCTIONS

PARTS INCLUDED IN THIS LIST:

ITEM	QTY	DESCRIPTION
A	2	BOARD
B	1	DRIVER FRONT MOTOR
C	1	DRIVER REAR MOTOR
D	1	PASSENGER FRONT MOTOR
E	1	PASSENGER REAR MOTOR
F	1	CONTROL MODULE
G	1	HARNES
H	2	WIRED MAGNETIC INDUCTION MODULE
I	4	DOOR MAGNET
J	4	LED LAMP
K	2	FUSE
L	1	VoltStep MANUAL SWITCH
M	2	M8X25 HEX FLANGE BOLT
N	8	M8X30 HEX FLANGE BOLT
O	8	M6X25MM SOCKET CAP SCREW
P	5	M8 RIVET NUT
R	1	RIVET NUT TOOL
S	25	ZIP TIES

RealTruck recommends you, the installer, read this installation instruction manual from front to back before installing the product. You may also [click here](#) to view an installation video or visit <https://realtruck.com/installation-instructions/>.

### TOOLS NEEDED FOR INSTALLATION:

- 5MM HEX KEY WRENCH (ALLEN WRENCH)
- 13MM SOCKET/ WRENCH
- PRY TOOLS
- STEP DRILL BIT
- WIRE STRIPPER
- ELECTRICAL TAPE
- 50/50 MIX OF ISOPROPYL ALCOHOL AND WATER

**ESTIMATED TIME FOR INSTALLATION:**

**2-3 HOURS**

If you need installation service for your new product, call the authorized distributor from whom you purchased the product or an authorized installation service company which can be found by calling toll free 1-888-427-4466.

# REALTRUCK

## INSTALLATION INSTRUCTIONS

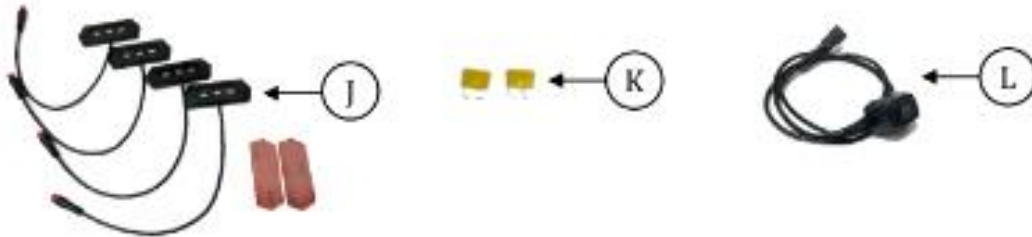
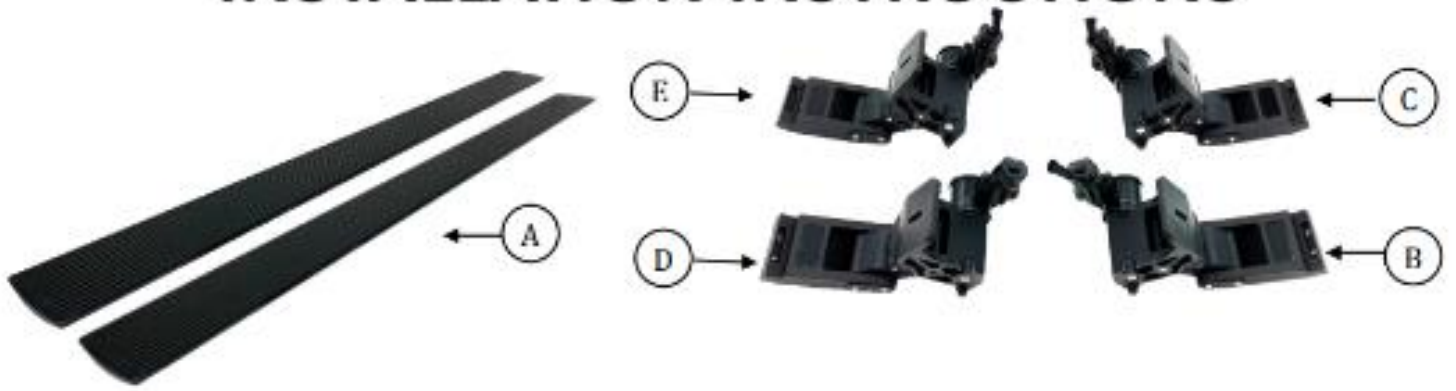



# REALTRUCK<sup>®</sup>

## INSTALLATION INSTRUCTIONS

### PASSENGER SIDE INSTALLATION LOCATIONS

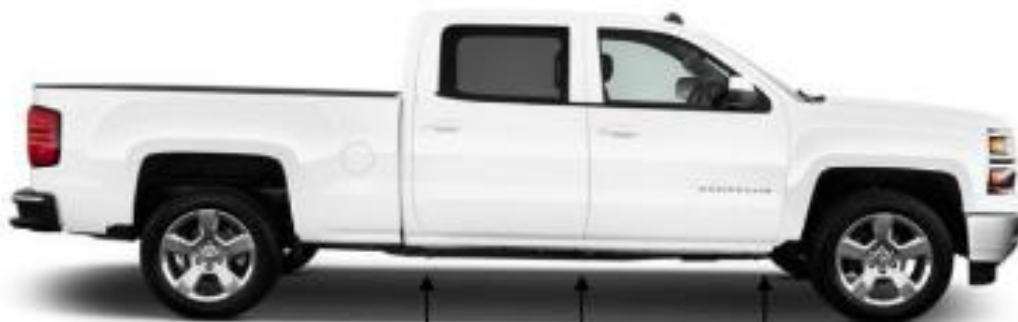

VoltStep Motors point towards the front tires



**Note:** Each motor is etched to call out what position it is installed in.

**Step 1:** Disconnect the battery. Begin with the negative battery terminal, followed by the positive terminal.

**Step 2:** On the Front Passenger side, inspect the motor and controller mounting threaded holes. If the holes have a heavy paint buildup from the factory, clean the threads with a screw thread tap. If your truck is equipped with threaded clip nuts as shown, skip to Step 5

**Step 3:** For vehicles without OEM clip Nuts. Using the installation tool and hardware provided, install a threaded insert (rivet nut) for the rear passenger side motor. Insert the rivet nut into the hole. Hold the tool with one hand and drive the bolt clockwise until it bottoms out.



# REALTRUCK<sup>®</sup>

## INSTALLATION INSTRUCTIONS

### PASSENGER INSTALLATION LOCATIONS



**Step 4:** Using the installation tool and hardware provided, install a threaded insert (rivet nut) for the Front passenger side motor.



Rivet Nut Tool

**Step 5:** Insert the rivet nut into the hole.



**Step 6:** Hold the rivet nut with one hand and drive the bolt clockwise until it bottoms out.



# REALTRUCK

## INSTALLATION INSTRUCTIONS

### PASSENGER INSTALLATION LOCATIONS



**Step 7 :** Install the Front Passenger Side Motor linkage using (2) M8X30MM flange bolts. The hardware should be hand tightened only until snug. This will allow the motor assembly to move and align easier when installing the running board.



**Note: 2007-2013 Models Only:** Use a suitable tool to remove the welded nut on the rocker panel and use an appropriate metal cutting tool to create a notch in the parking brake bracket that runs along the rocker panel . Sand and paint the previously cut bracket to reduce rust

# REALTRUCK

## INSTALLATION INSTRUCTIONS

### PASSENGER INSTALLATION LOCATIONS



**Step 8:** Install the controller module using (2) M8X25 flange bolts and on M8 Hex Nut for the bottom bolt on the center mounting location. Using a torque wrench, tighten to 18 ft-lb. If the upper mounting hole does not have a OEM clip nut, install M8 nutsert (steps 4-6).



**Step 9 :** Install the Rear Passenger Side Motor linkage using (2) M8X30MM flange bolts. The hardware should be hand tightened only until snug. This will allow the motor assembly to move and align easier when installing the running board. If the upper mounting hole does not have a OEM clip nut, install M8 nutsert (steps 4-6).

# REALTRUCK

## INSTALLATION INSTRUCTIONS

### PASSENGER SIDE INSTALLATION LOCATIONS



**Step 10:** Install the Passenger side running board. With assistance, begin by positioning the board on the front and rear motor assembly bases. Align the sliding T-Nut on the running board with the slots on the front and rear motor base. Once the T-Nuts are aligned, rotate the running board so that the T-Nuts set in the slots on the base of the arms. Repeat Steps 2-9 to install the motor linkage assemblies and running board on the Driver side.



**Step 11:** Determine where you want to position the board and secure the running board to the arms using the (2 per bracket) M6x25 socket head cap screws. Using a torque wrench, tighten to 9 ft-lbs. With the running board is installed, fasten the hardware on the Passenger side front and rear motor assemblies. Using a torque wrench, tighten the mounting hardware to 18 ft-lbs.

# REALTRUCK<sup>®</sup>

## INSTALLATION INSTRUCTIONS

### DRIVER SIDE INSTALLATION LOCATIONS

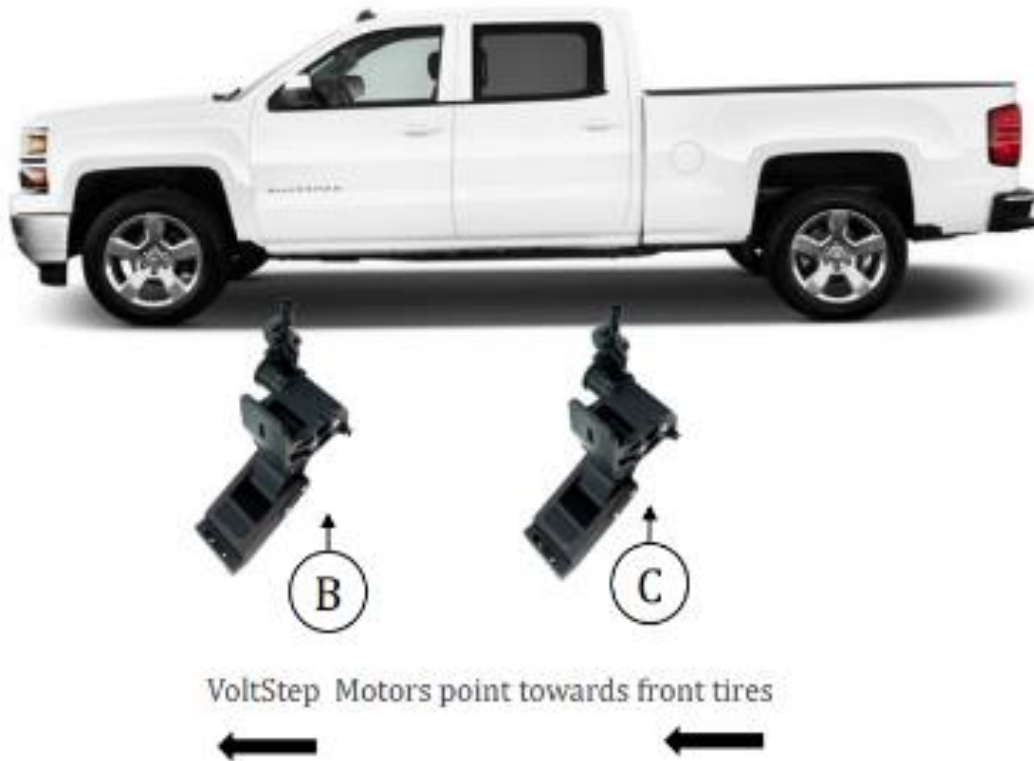

**Step 12:** Repeat Steps 2-9 to install the motor linkage assemblies. Repeat steps 10-11 to install running board on the Driver side.

# REALTRUCK

## INSTALLATION INSTRUCTIONS

### Wiring your VoltSteps

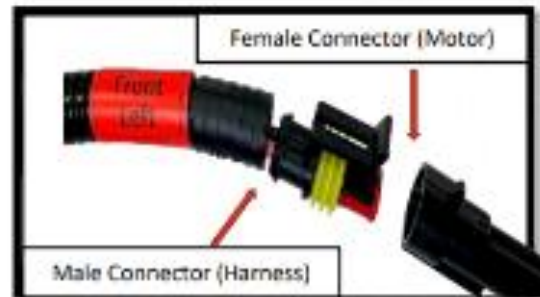
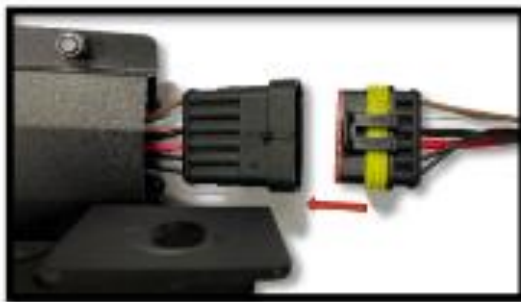
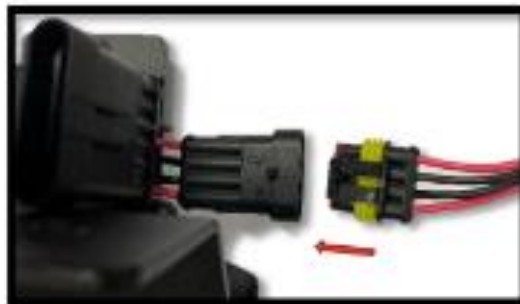
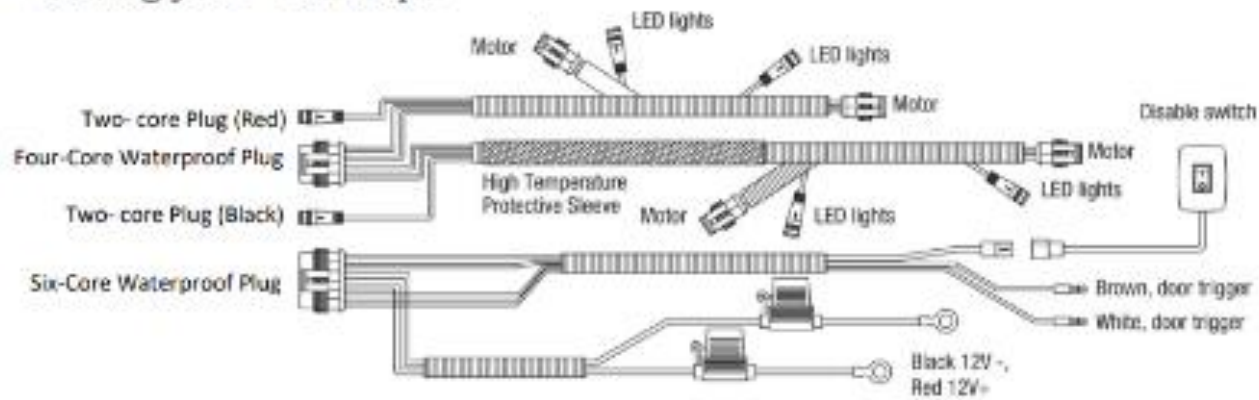

**Step 13:** With the control module installed, plug in the harness connectors to the corresponding connectors. On the round connectors, make sure you plug in red to red and black to black. Route the electrical harness from the controller along the frame rail of the truck. Connect the male plug connector on the wire harness into the female socket on the motors. The harness is labeled to show where to plug each male connector to the female connector. For example, Front Left is for the front Driver side motor and Rear Left for the rear Driver side motor. Use supplied zip-ties to secure harness to the frame rail.

**Step 14:** Connect the male plug connector on the wire harness into the female socket on the motors. The harness is labeled Front Right for the front Passenger side motor and Rear Right for the rear Passenger side motor.

# REALTRUCK

## INSTALLATION INSTRUCTIONS

### Wiring your VoltSteps

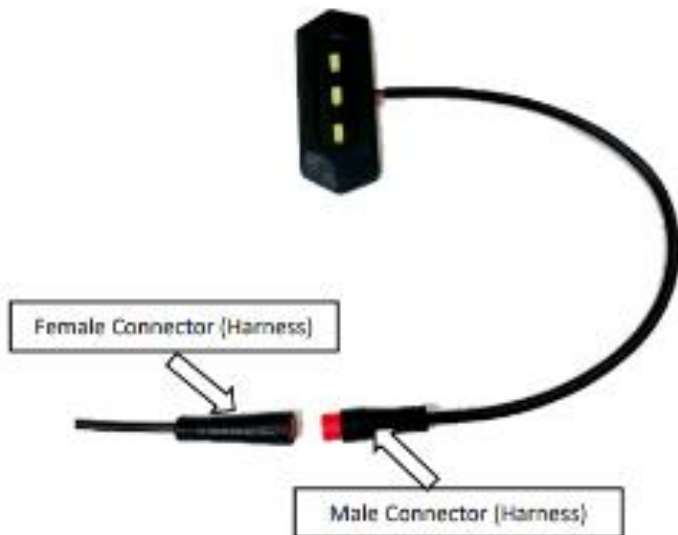

**Step 15:** Align the arrows on the small round connectors and plug the Passenger side front and Passenger side rear LED lights. Prepare the surface by cleaning with a 50/50 mix of isopropyl alcohol and water or equivalent. Once the surface is completely dry, peel the backing from the double-sided tape and stick the LEDs to the bottom side of the rocker panel. Position the LED lights at the center of the front and rear passenger side doors



**Step 16:** Route the motor and LED wire harness from the controller to the Driver side frame rail of the vehicle. When routing the harness keep clear from any moving parts and avoid direct contact with the exhaust system.

# REALTRUCK

## INSTALLATION INSTRUCTIONS

### Wiring your VoltSteps – Crew Cab

**Step 17:** On the passenger side, remove the front kick panel, front door sill trim panel, and b-pillar trim panel. Pull the front passenger carpet back and drill a 7/16" hole on the plastic grommet as shown. Feed the door trigger signal wires (white and brown) and the disable switch wires (two black wires) into the cab. Seal around the wires using RTV silicone adhesive to prevent water intrusion.



Remove A-pillar, Sill Panel, b-pillar trim and carpet



Passenger Side carpet, pull back to expose grommet opening

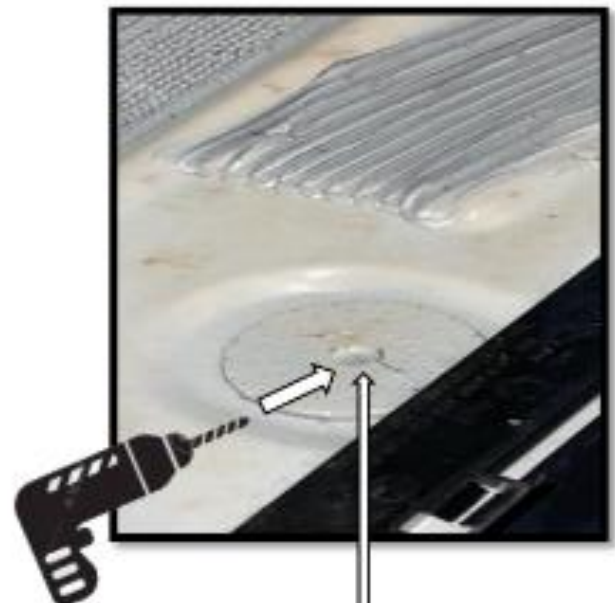

Drill 7/8" hole and seal with RTV Silicone

# REALTRUCK

## INSTALLATION INSTRUCTIONS

### Wiring your VoltSteps – Crew Cab



**Step 18:** Route the passenger side door trigger wire (brown) towards the passenger side b-pillar. Route the driver side door trigger wire (white) and the black disable switch wires under the center console to the left side of the vehicle. The white wire needs to go to the driver side b-pillar, the black wires will go to the center console.



**Step 19:** The door trigger sensor harness will need a ground connection to the vehicle. Locate the seat belt assembly at the passenger side b-pillar and install the ground wire under the top bolt of the seat belt assembly.

Connect the snap-in bullet connector to the brown wire on the Passenger side b-pillar



Passenger Side (Brown)

WIRED MAGNETIC INDUCTION MODULE

# REALTRUCK

## INSTALLATION INSTRUCTIONS

### Wiring your VoltSteps – Crew Cab



**Step 20: FRONT DOOR** Apply a vertically oriented strip of masking tape on the front passenger side door using the deepest part of the latch as a reference point. Make a mark 2" below the center line of the latch. Prepare the surface by cleaning with a 50/50 mix of isopropyl alcohol and water or equivalent. Once the surface is completely dry, peel the backing from the double-sided tape and stick the magnet to the door. Align the top of the magnet with the 2" mark as shown.

**Step 21:** Apply a vertically oriented strip of masking tape on the door jamb using the outer edge of the front passenger side door striker as a reference point. Make a mark 2" below the center line of the striker. Lift the bulb door seal to route the sensor wire underneath it. Prepare the surface by cleaning with a 50/50 mix of isopropyl alcohol and water or equivalent. Once the surface is completely dry, peel the backing from the double-sided tape and stick the sensor to the b-pillar. Align the top of the sensor with the 2" mark as shown.



**Note: Magnet and Sensor Positioning.** The measurement shown is for reference only and can be adjusted depending on the vehicle application. The magnet needs to align with the sensor in order to operate. With the magnets in position and the power switched on, test the boards by opening each door independently to ensure proper step function. Once all magnet locations are confirmed and the system is operating correctly, mark the magnet positions and permanently install using the round double-sided tape. If the boards do not deploy, inspect the magnet position and realign with the sensor.

# REALTRUCK

## INSTALLATION INSTRUCTIONS

### Wiring your VoltSteps – Crew Cab

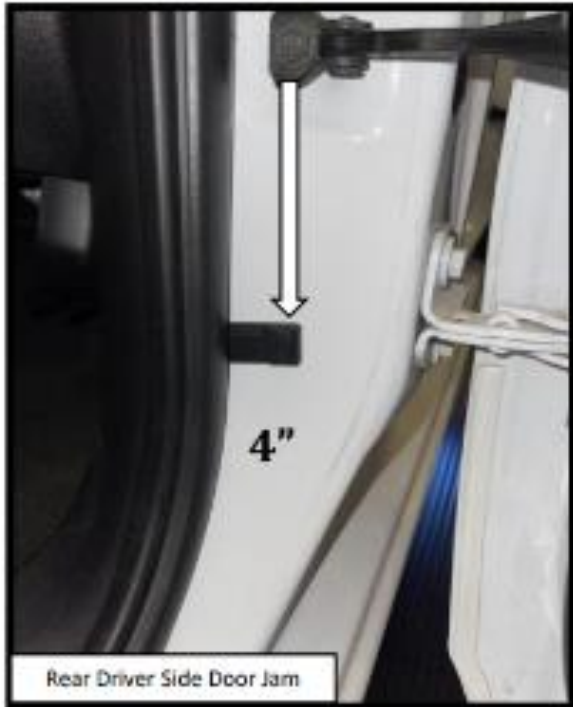

**Step 22: REAR DOOR** Apply a vertically oriented strip of masking tape on the rear passenger side door jamb using the outside edge of the door detent mounting bracket as a reference point. Make a mark 4" below the center line of the door detent. Prepare the surface by cleaning with a 50/50 mix of isopropyl alcohol and water or equivalent. Lift the bulb door seal to route the sensor wire underneath it. Once the surface is completely dry, peel the backing from the double-sided tape and stick the rear door sensor to the door jamb. Align the top of the sensor with the 4" mark as shown

**Step 23:** With the rear passenger side sensor attached, you can determine the correct position for the door magnet. peel the backing from the double-sided tape and stick the magnet on the door. Align the bottom of the magnet with the 4"

**Step 24:** Repeat steps 18-24 to install the Driver side door trigger sensors and magnets. The Driver side door trigger harness is connected to the white wire that was routed under the carpet to the Driver side b-pillar in Step 17.

**Note: Magnet and Sensor Positioning.** The measurement shown is for reference only and can be adjusted depending on the vehicle application. The magnet needs to align with the sensor in order to operate. With the magnets in position and the power switched on, test the boards by opening each door independently to ensure proper step function. Once all magnet locations are confirmed and the system is operating correctly, mark the magnet positions and permanently install using the round double-sided tape. If the boards do not deploy, inspect the magnet position and realign with the sensor.

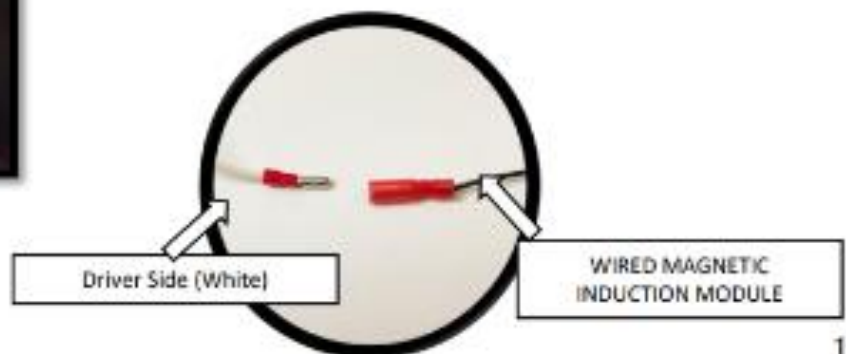

# REALTRUCK

## INSTALLATION INSTRUCTIONS

### Wiring your VoltSteps – Extended Cab



DOOR SENSORS

**Step 22\*:** EXTENDED CAB TRUCKS Install both sensors side by side on the front of the door near the lower door hinge. You will need to ground the sensors on an exposed stud where the interior kick panels are. The door magnets will need to be installed on the door and aligned with the door sensors.



DOOR MAGNETS

# REALTRUCK

## INSTALLATION INSTRUCTIONS

### Wiring your VoltSteps



**Step 22:** Locate the black wires for the disable switch and feed them to your desired mount location. Prepare the surface by cleaning with a 50/50 mix of isopropyl alcohol and water or equivalent. Once the surface is dry, peel the backing from the double-sided tape and stick the disable switch on the lower dash panel. Plug the disable switch connector into the black wire harness and tuck the extra wire behind the lower dash panel.

**Step 23:** Remove the 20 Amp fuses from the main positive and negative 12V power leads on the main harness. Route the power wires over the wheel well and into the engine compartment. Connect the ring terminals to the battery positive and negative terminals. Install the 20 Amp fuses back into the main negative and positive power lead fuse holders. Connect the battery terminals. Begin with the positive terminal followed by the negative terminal.

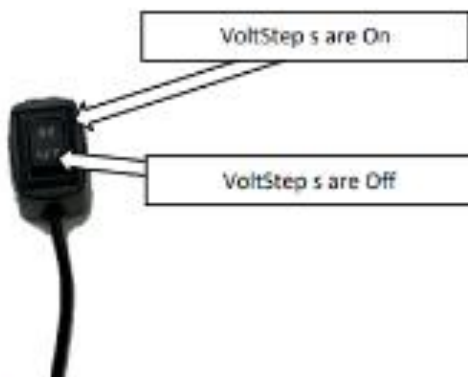
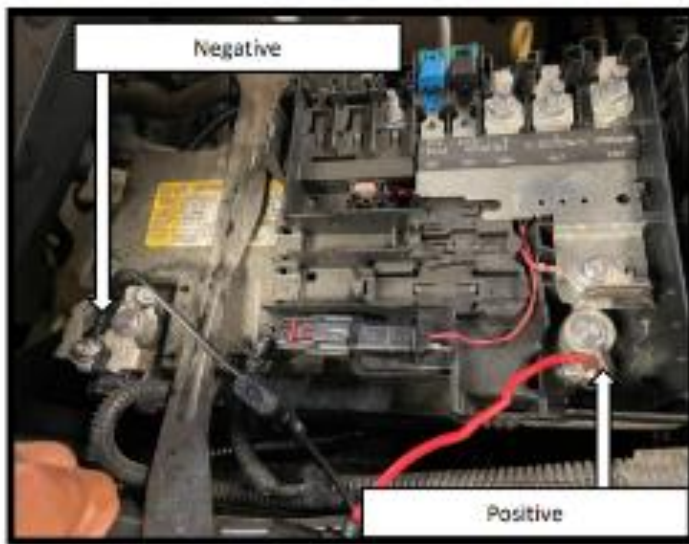

**Step 24:** Open the Driver side door and keep the door open. Flip the disable switch to the Off position. This will signal the running boards to retract to the stowed position and it will disable any further operation until the switch is flipped to the On position.

# REALTRUCK<sup>®</sup>

## INSTALLATION INSTRUCTIONS

### LIMITED WARRANTY

RealTruck Automotive warrants to Buyer that for a period of five (5) years from the date of shipment of the product(s) ("Warranty Period") for black finishes and chrome finishes, that such products will materially conform to the specifications set forth in RealTruck Automotive's specifications in effect as of the date of shipment(s) and will be free from material defects in material workmanship.

RealTruck Automotive warrants to Buyer that for the life of the product(s) from the date of shipment of the product(s) ("Warranty Period") for polished stainless steel finished products purchased after April 2004, that such products will materially conform to the specifications set forth in RealTruck Automotive's specifications in effect as of the date of shipments and will be free from material defects in material workmanship.

Warranty claims must be accompanied with the original invoice and photos of the product. It is the customer's responsibility to clean regularly and protect finish with regular applications of a nonabrasive polish that is compatible with the product's finish.

This warranty covers the cost of the product only and does not include the cost of removal, installation, third party modifications or shipping of the product. In no event shall RealTruck Automotive be liable to buyer or any third party for any damage or harm caused by the product or use thereof, regardless of weather such damages were foreseeable and whether or not RealTruck Automotive has been advised of the possibility of such damages, notwithstanding the failure of any agreed or other remedy of its essential purpose. This warranty is void if the product shows signs of alteration, misuse, mishandling, improper care, neglect, improper application and/or damage due to improper installation.

With respect to any such product(s) during the limited warranty period, RealTruck Automotive shall, in its sole discretion, either: (i) provide a one-time repair or replacement of such products (or the defective part) or (ii) credit or refund the price of such products at the pro rata contract rate provided that, if RealTruck Automotive so requests, Buyer shall, at RealTruck Automotive's expense, return such product(s) to RealTruck Automotive. The remedies shall be the Buyer's sole and exclusive remedy and RealTruck Automotive's entire liability for any breach of the limited warrant(ies).

RealTruck Automotive disclaims all other warranties except to the extent that any such warranty cannot be validly disclaimed under applicable law.

#### **Finish Limited Warranty:**

Limited lifetime on stainless steel products (after April 2004)

5 year warranty on black powder coat products

5 year warranty on chrome products

This warranty does not cover exposed welds

#### **Electronics Limited Warranty:**

1 year warranty VoltStep Motors or electronics

Finish warranty covers peeling, flaking, or cracking. Washing all finishes regularly with car wash soap and rinsing well with water is the best method for maintaining the finish on your products. You must also protect the finish with nonabrasive automotive wax on a regular basis. The use of any compound which contains abrasives becomes a self-defeating exercise as the compound scratches the finish and opens it to corrosion. The use of harsh chemicals used to remove bugs and tar may also cause the finish to fail and should be avoided.

If you are unsatisfied with your purchase please contact the establishment you purchased the product from.

If you need to place a warranty claim or need assistance, the RealTruck Automotive customer service team will answer any questions you may have. Please contact the RealTruck Automotive customer service team at 1-888-427-4466 during normal business hours Monday thru Friday 7 am to 5 pm PST. You may also email <https://realtruck.com/contact-realtruck-com>. In order to better serve you please provide a copy of the original invoice / receipt, a photo of the issue you are experiencing and a photo of the vehicle the product is installed on.

All warranty returns must have an approved RGA number. The RGA number must be clearly marked on the exterior of the return package. All approved warranty returns must be shipped to RealTruck Automotive Products, 1002 Carriers Drive, Laredo, Texas 78045.

#### **PRODUCT REGISTRATION**

Please remember to register your new purchase. You may register your product at <https://realtruck.com/warranty-registration>

. Registering your product may help speed any future warranty or customer service inquiries.

**Thank you again for purchasing from RealTruck Products**

Please take a few minutes to view additional products for your vehicle and more at [realtruck.com](https://realtruck.com)  
These installation instructions are available on the Real Truck web site along with installation videos for many of our products.