



## INSTALLATION INSTRUCTIONS

### 57-1515-1 CHRYSLER 2001-05 PT Cruiser L4-2.4L (exc. Turbo)

#### TOOLS NEEDED:

Flat Blade Screwdriver  
Ratchet  
Long Extension  
Universal Swivel  
9/16" Socket  
4mm Allen Wrench  
10mm Wrench  
7/16" Wrench

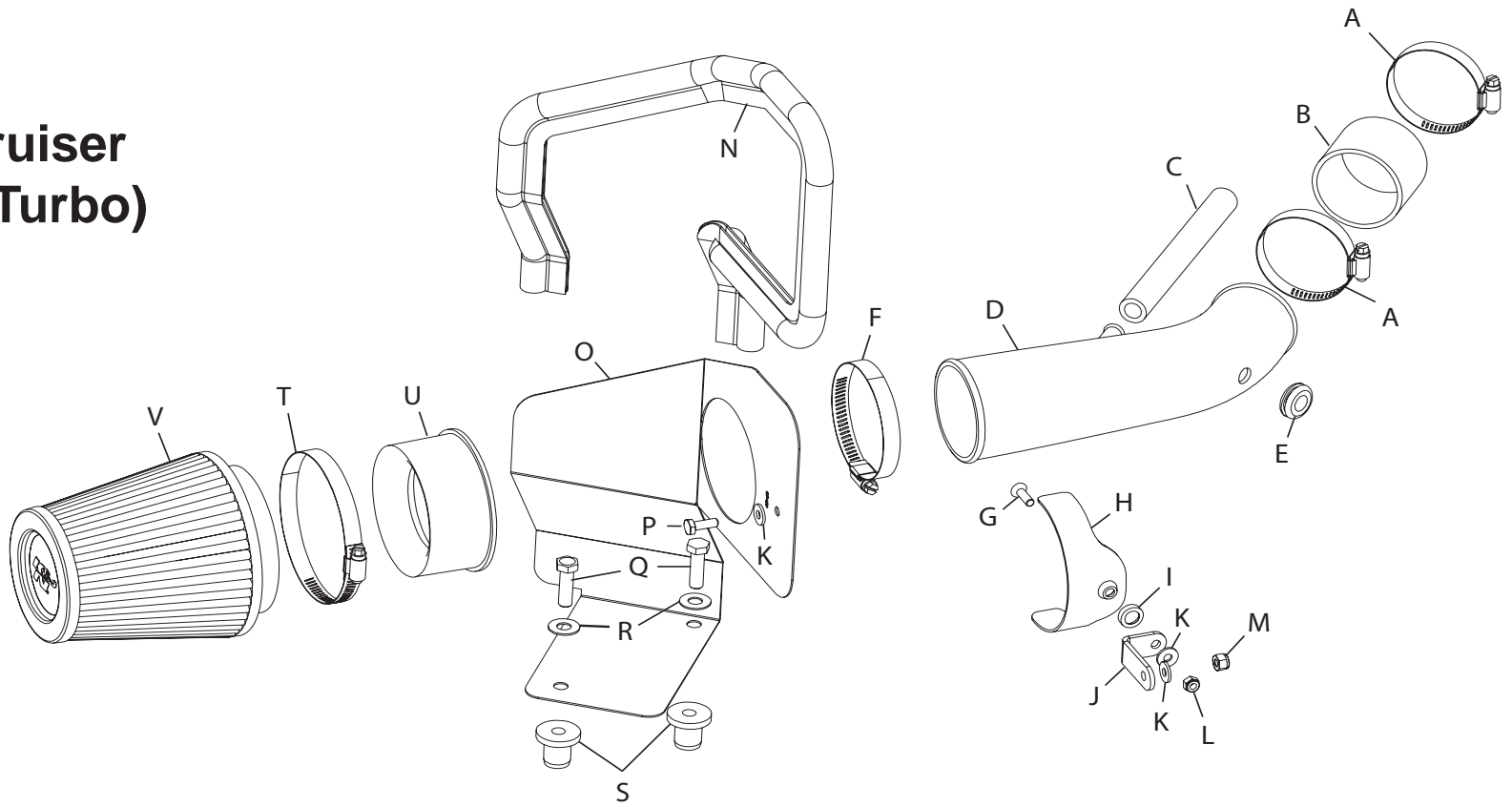

#### PARTS LIST:

Description	Qty.	Part #	Description	Qty.	Part #	Description	Qty.	Part #
A Hose Clamp #36	2	08530	I Conical Washer	1	08180	Q Bolt 3/8-16 HexHead	2	07779
B Silicone Hose	1	08405	J Bracket	1	07078	R Washer 3/4 Flat S.S.	2	08134
C Vent Hose	1	08159	K 1/4" Washer	3	08275	S Nut Insert Rubber Plug	2	08163
D Intake Tube	1	26094	L Nut 6mm Nyloc	1	07553	T Hose Clamp #64	1	08648
E Grommet	1	080544	M Nut 1/4-20 Nyloc	1	07517	U Filter Adapter	1	21561
F Hose Clamp #48	1	08601	N Edge Trim 39" Long	1	102496	V Air Filter	1	RP-4660
G Bolt 6mm	1	08376	O Heat Shield	1	07429			
H Saddle Bracket	1	078855	P Bolt 1/4-20 HexHead	1	08386			

**NOTE: FAILURE TO FOLLOW INSTALLATION INSTRUCTIONS AND NOT USING THE PROVIDED HARDWARE MAY DAMAGE THE INTAKE TUBE, THROTTLE BODY AND ENGINE.**

#### TO START:

1. Turn off the ignition and disconnect the negative battery cable.

**NOTE: Disconnecting the negative battery cable erases pre-programmed electronic memories. Write down all memory settings before disconnecting the negative battery cable. Some radios will require an anti-theft code to be entered after the battery is reconnected. The anti-theft code is typically supplied with your owner's manual. In the event your vehicles' anti-theft code cannot be recovered, contact an authorized dealership to obtain your vehicles anti-theft code.**

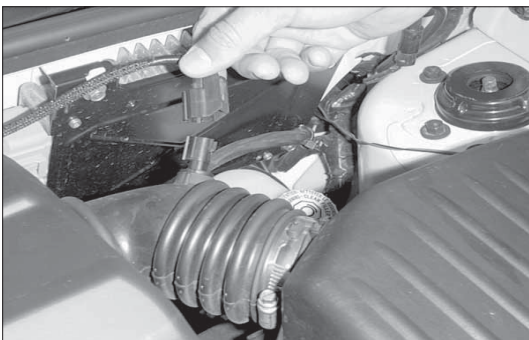

2. Disconnect the air temperature sensor electrical connection.



3. Pull firmly up on the engine cover to remove.

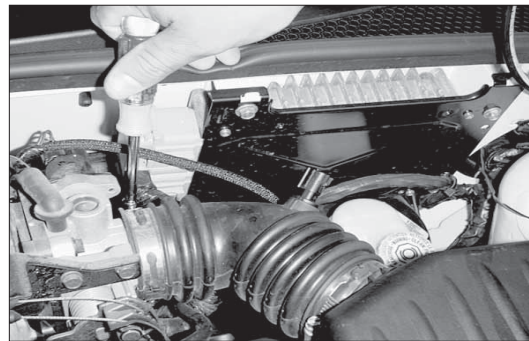

4. Loosen the hose clamps on the air intake tube at the throttle body and air box.

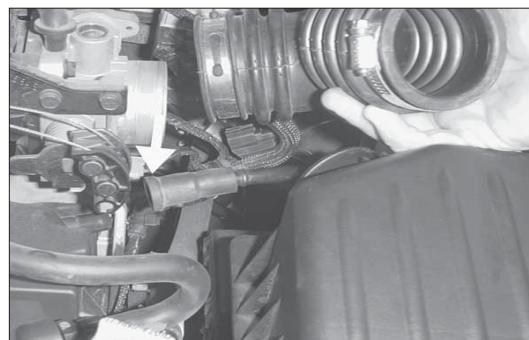

5. Disconnect the crank case vent from the valve cover.

6. Remove the air intake hose and crank case vent from vehicle.

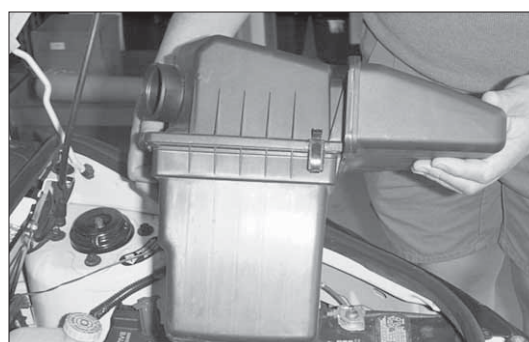

7. Lift firmly up on the air box to remove from the car.

**NOTE: K&N Engineering, Inc., recommends that customers do not discard factory air intake.**



8. Remove the stock air box grommets from the stock air box mounting tray.



9. Assemble the saddle bracket assembly with the provided hardware (as shown above).



10. Install the edge seal to the heat shield as shown.

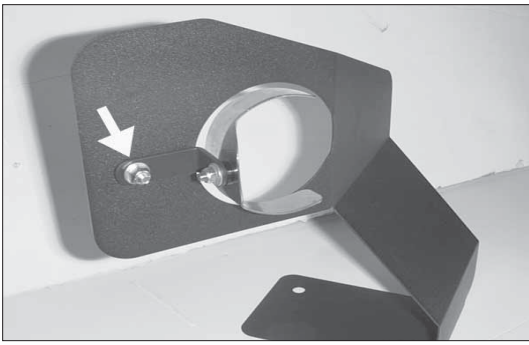

11. Mount the saddle bracket assembly to the heat shield (as shown).

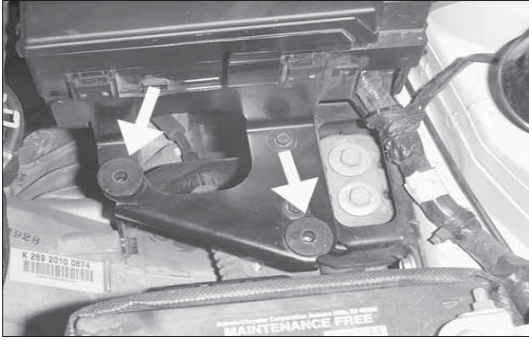

12. Install the rubber nut insert into air box grommet holes.

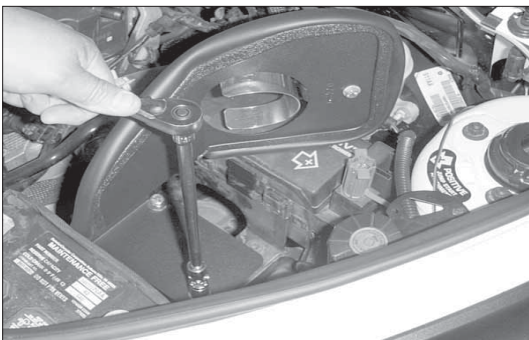

13. Install the heat shield with hardware provided (as shown).



14. Remove the air temperature sensor from the stock air intake tube.

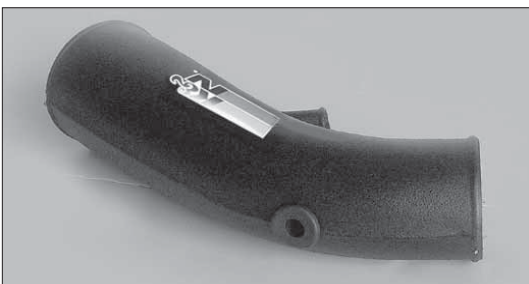

15. Install the grommet into the new intake tube.

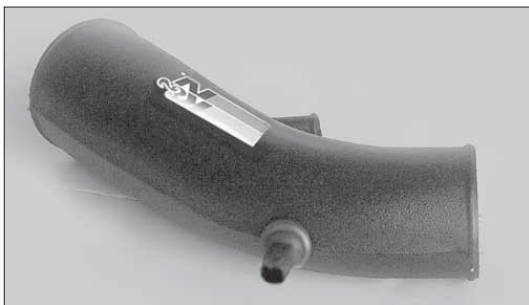

16. Install the air temperature sensor into the new intake tube.



17. Install the silicone hose and hose clamps onto the new intake tube.

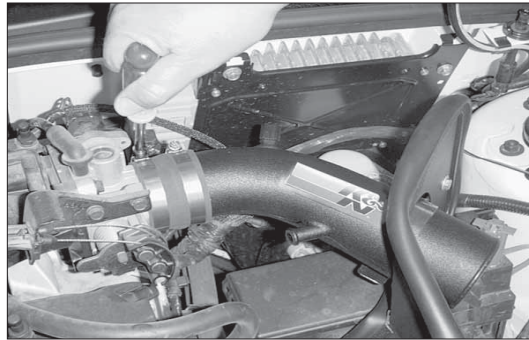

18. Install the air intake tube onto the throttle body.



19. Secure the intake tube to the saddle bracket with the hardware provided.



20. Install the filter adapter onto the intake tube.

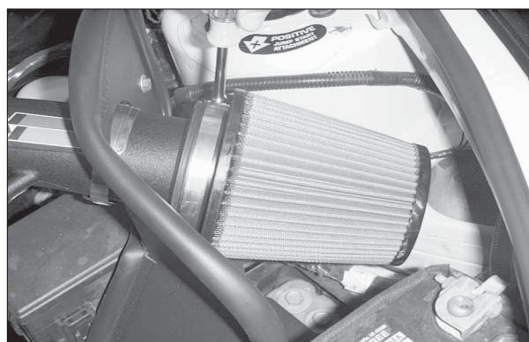

21. Install the air filter onto the intake tube.

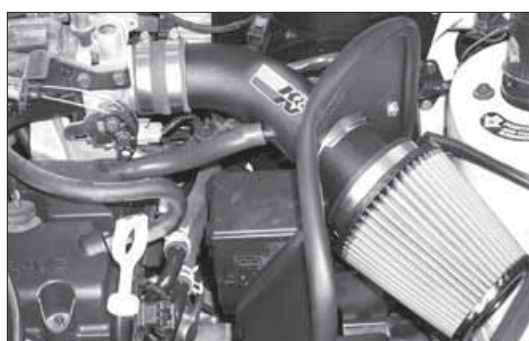

22. Install the crank case vent hose onto the intake tube and valve cover.

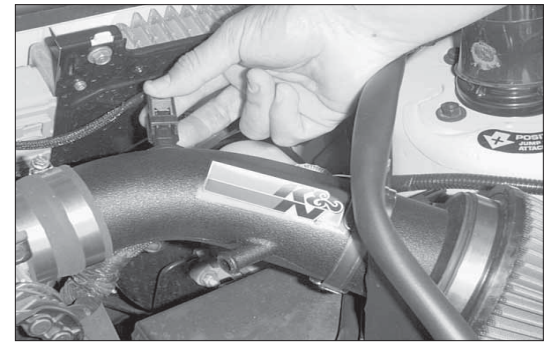

23. Reconnect the air temperature sensor electrical connection.

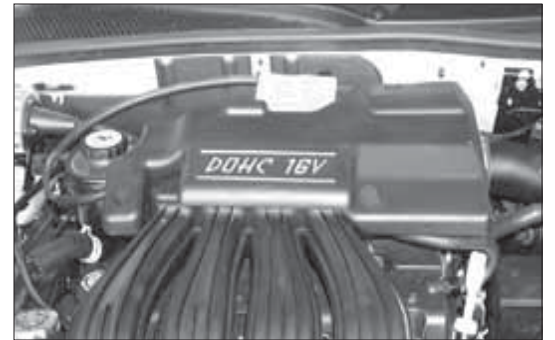

24. Install the engine cover back onto motor.

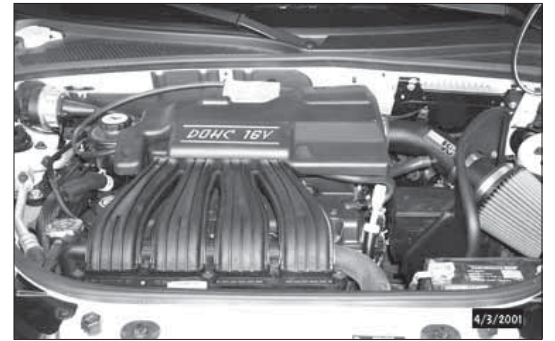

##. Reconnect the vehicle's negative battery cable. Double check to make sure everything is tight and properly positioned before starting the vehicle.

##. The C.A.R.B. exemption sticker, (attached), must be visible under the hood so that an emissions inspector can see it when the vehicle is required to be tested for emissions. California requires testing every two years, other states may vary.

##. It will be necessary for all K&N® high flow intake systems to be checked periodically for realignment, clearance and tightening of all connections. Failure to follow the above instructions or proper maintenance may void warranty.

#### ROAD TESTING:

1. Start the engine with the transmission in neutral or park. Listen for air leaks or odd noises. For air leaks secure hoses and connections. For odd noises, find cause and repair before proceeding. This kit will function identically to the factory system except for being louder and much more responsive.

2. Test drive the vehicle. Listen for odd noises or rattles and fix as necessary.

3. If road test is fine, you can now enjoy the added power and performance from your kit.

4. K&N Engineering, Inc., suggests checking the air filter element periodically for excessive dirt build-up. When the element becomes covered in dirt (or once a year), service it according to the instructions on the Recharger® service kit, part number 99-5050 or 99-5000.

**50-STATE STREET LEGAL**  
**K&N CARB EXEMPT**  
**K&N**

\* FREE K&N® decal To register your warranty, please see us online at [knfilters.com/register](http://knfilters.com/register). FREE K&N® decal \*

• 1455 CITRUS ST., P.O. BOX 1329, RIVERSIDE, CA., U.S.A. 92502 • TECH SERVICE 800-858-3333 • FAX 951-826-4001  
 • e-mail: [tech@knfilters.com](mailto:tech@knfilters.com) • WWW: <http://www.knfilters.com>

17261h  
 2/18/10