

4

3

2

1

D

D

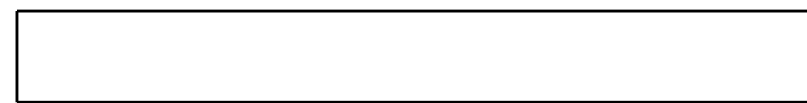
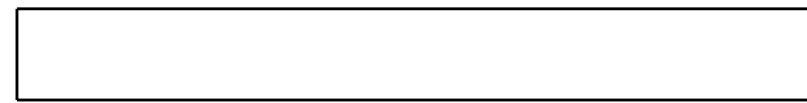
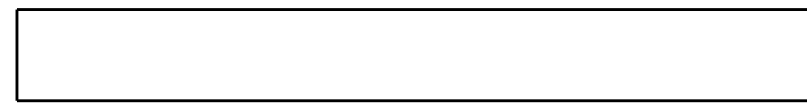
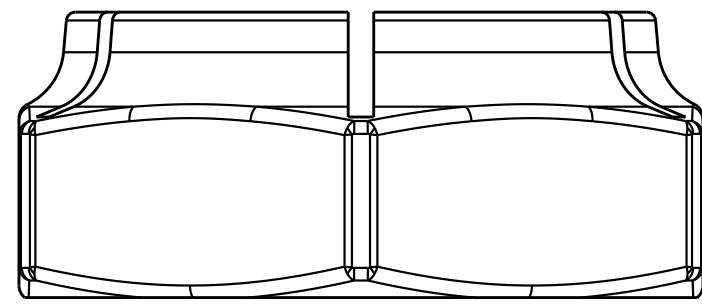

(3X) BACK UP WASHER

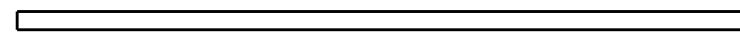

(2X) 0.800 X .020

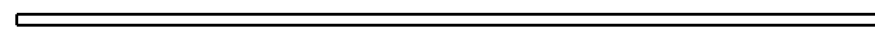
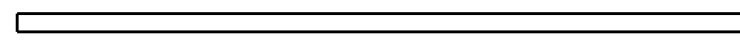

0.950 X .012

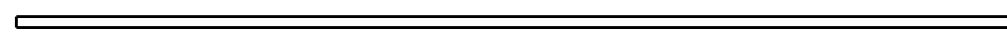

1.100 X .012

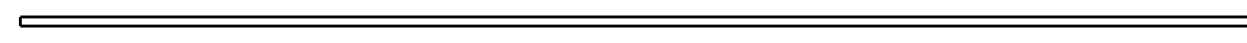

1.350 X .010

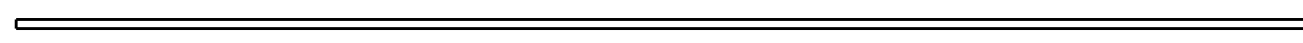

1.425 X .010

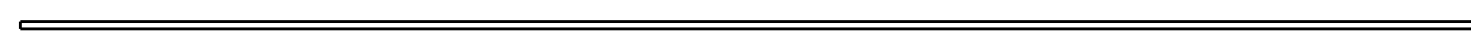
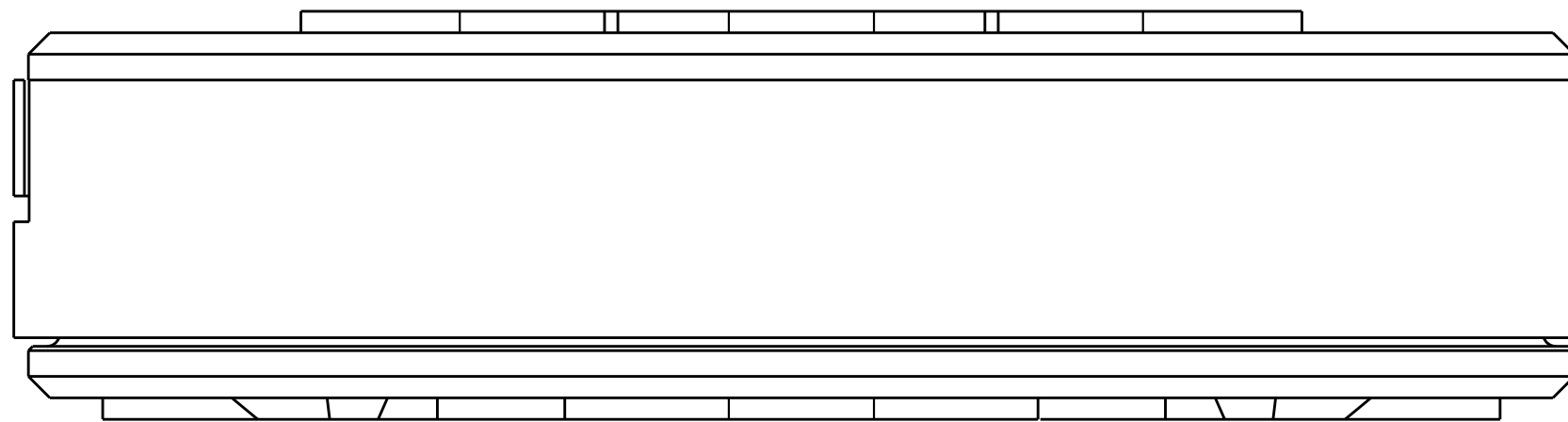

1.600 X .008

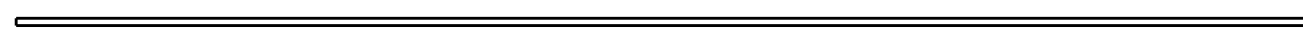

1.425 X .008

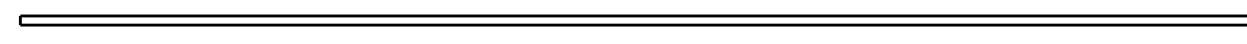

1.350 X .010

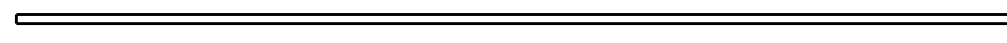

1.100 X .010



0.950 X .010

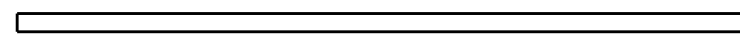

0.800 X .020

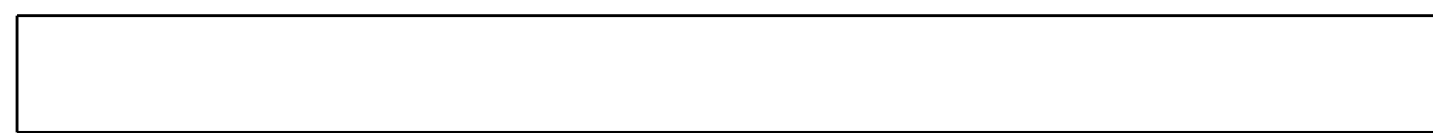

TOP OUT WASHER

C

C

B

B

A

A

- PROPRIETARY -
 THIS DOCUMENT CONTAINS CONFIDENTIAL, PROPRIETARY INFORMATION
 THAT IS FOX PROPERTY. DO NOT DISCLOSE TO OR DUPLICATE
 FOR OTHERS EXCEPT AS AUTHORIZED BY FOX.

SIZE	DWG. NO.	REV.
C	807-24-002	
PLOT SCALE	1.50:1	SHEET
		2 OF 2

4

3

2

1