

Installation Instructions

Eibach Inc. 264 Mariah Circle Corona, CA 92879
USA Tech Support 800-507-2338 ext. 114



PRO-TRUCK COILOVER SYSTEM 2.0: E86-23-042-04-22

23+ CHEVY COLORADO Z71

Notes

Please note the driver and passenger side stickers on the coilovers. They indicate which side to install each coilover.

Kit Contents

Description	Part Number	Quantity
Driver Side Pro-Truck Coilover	38187.9003-D	1
Passenger Side Pro-Truck Coilover	38187.9003-P	1
Pro Truck Reservoir Shock	38187.8004RR	2
Dust Boot	84-2015	2
Cable Tie	H70065500	2
Spanner Wrench	ETCO2.0	1

Installation Notes

Read all instructions before beginning installation

- Only qualified mechanics experienced in the installation and removal of suspension components should perform this installation.
- Use of a hoist and screw jack is highly recommended and will substantially reduce installation time.
- Never work on or under a vehicle unless it is properly supported by safety stands and wheels are blocked.
- Never use impact wrenches or impact guns to install or remove shock absorber piston components, shafts and Piston rod nuts.
- All Eibach springs should be installed with the Eibach logo right-side-up.
- After Installation, inspect and adjust the following: Wheel Alignment; tire/wheel fender clearance when using aftermarket wheels or tires; brake line clearance and attachments; anti-lock-brake system sensors.



Step 1. Lift and support vehicle.



Step 2. Remove front tire using 21mm.

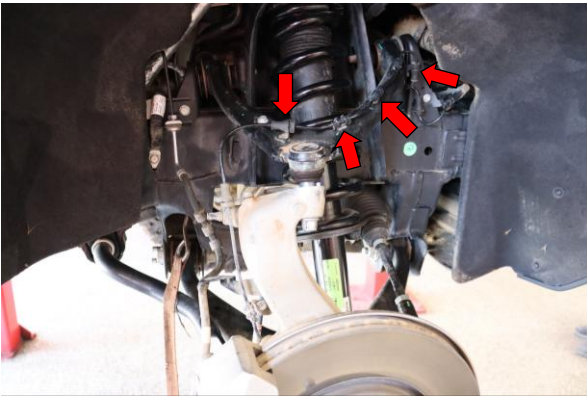

Step 3. Remove wire harness clips from upper control arm.



Step 4. Use a strap to prevent over extension of the axle during shock removal and installation.

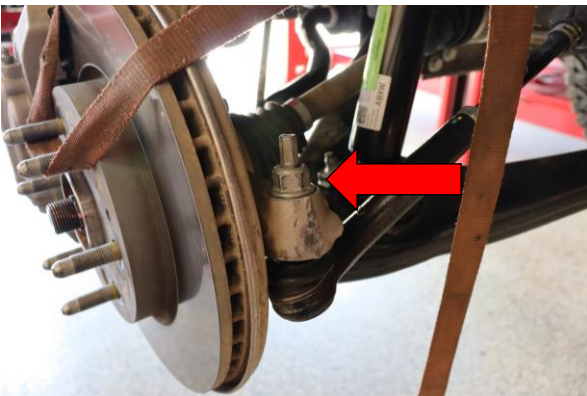

Step 5. Use a 21mm to remove the tie rod nut.

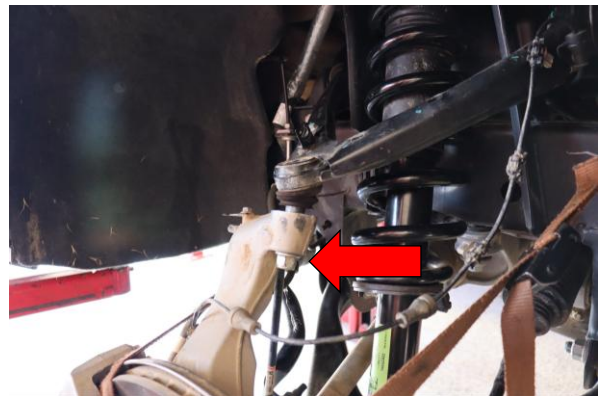

Step 6. Use an 18mm to loosen the upper ball joint nut. **DO NOT** remove it at this time.



Step 7. Use a hammer to shock and separate the upper ball joint and outer tie-rod end.



Step 8. Use a pry bar to lower the upper control arm. Remove the 18mm upper ball joint nut. Slowly allow the upper control arm to lift out of the steering knuckle. Allow the knuckle to rest against the strap installed in step 4.

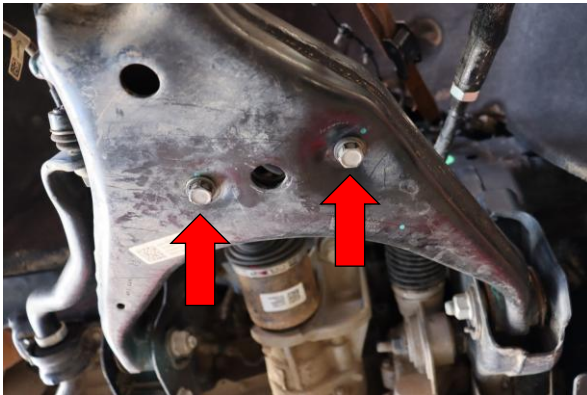

Step 9. Remove two 15mm bolts securing the lower shock mount to the lower control arm.

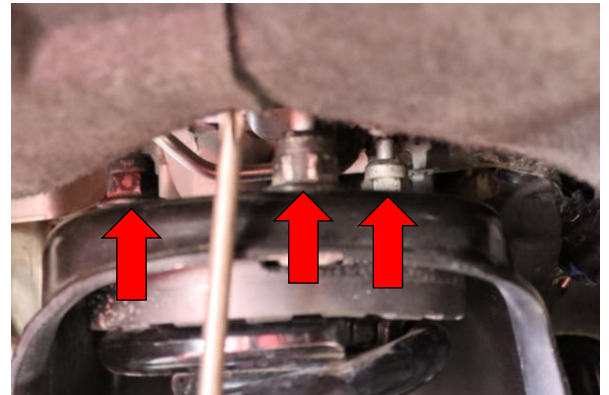

Step 10. Remove the three 18mm nuts from the upper shock mount.



Step 11. Remove the shock assembly from the vehicle.

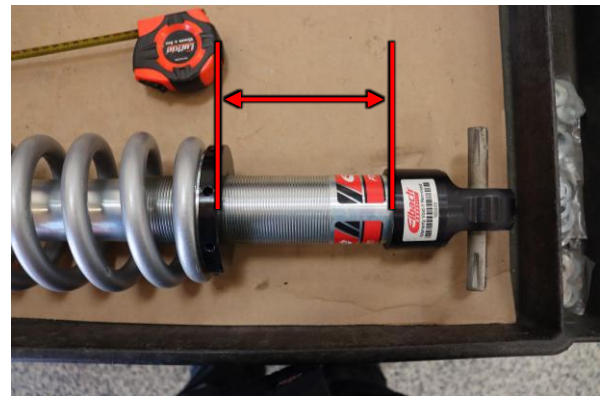

Step 12. Verify the height of the lower spring perch on the Eibach coilover by measuring from the bottom of the perch to the top of the lower shock mount. The default setting of 72mm will achieve a level ride height with the OEM rear spring. Additional pre-load of the spring should be used only for applications with additional weight.



Step 13. Install the Eibach coilover assembly in the vehicle.

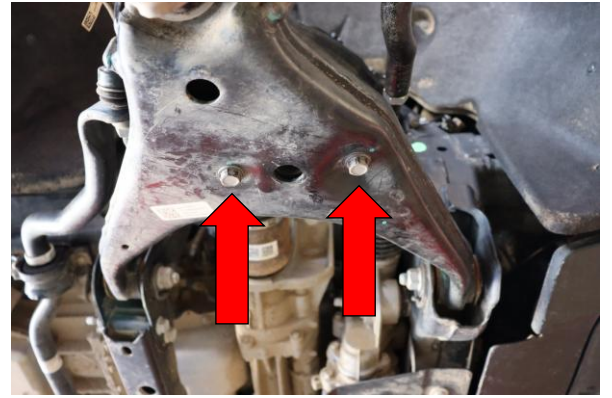

Step 14. Install two 15mm lower shock mount bolts and tighten to manufacturer specification.

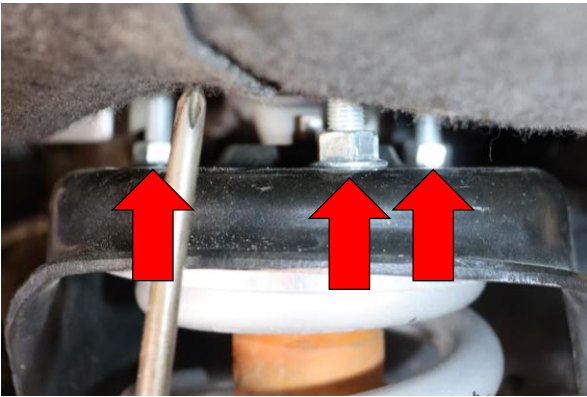

Step 15. Install supplied 15mm upper shock mount nuts and tighten to manufacturer specification.

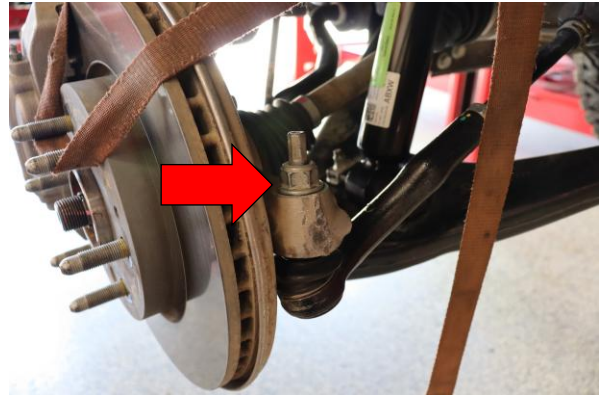

Step 16. Install outer tie rod end ball joint in the steering knuckle. Install and tighten 21mm to manufacturer specification.



Step 17. Use a pry bar to lower the upper control arm and ball joint into the steering knuckle. Install and tighten the 18mm ball joint nut to manufacturer specification.

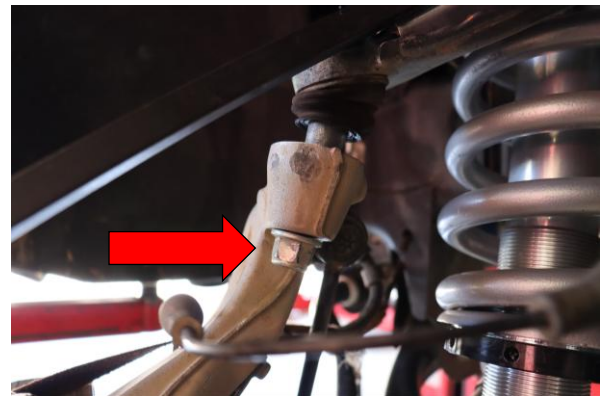

Step 18. Install and tighten the 18mm ball joint nut to manufacturer specification.

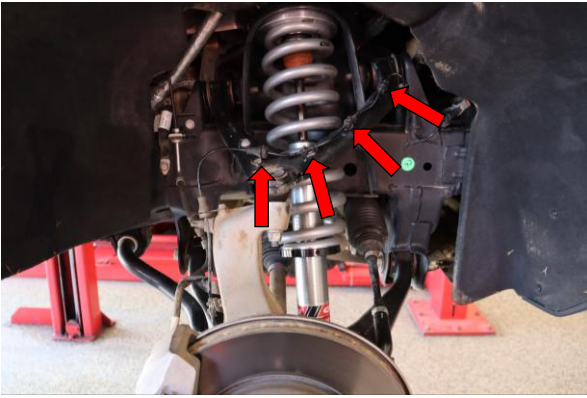

Step 19. Remove the strap installed in step 4. Install wheel speed sensor wire harness in original clip locations.



Step 20. Install wheel and tire. Tighten 21mm lug nuts to manufacturer specification.



Step 21. Lower vehicle and test drive while listening for any abnormal noises. Some adjustment of coilover spring perch height may be needed to achieve desired ride height depending on any weight that has been added to your vehicle.

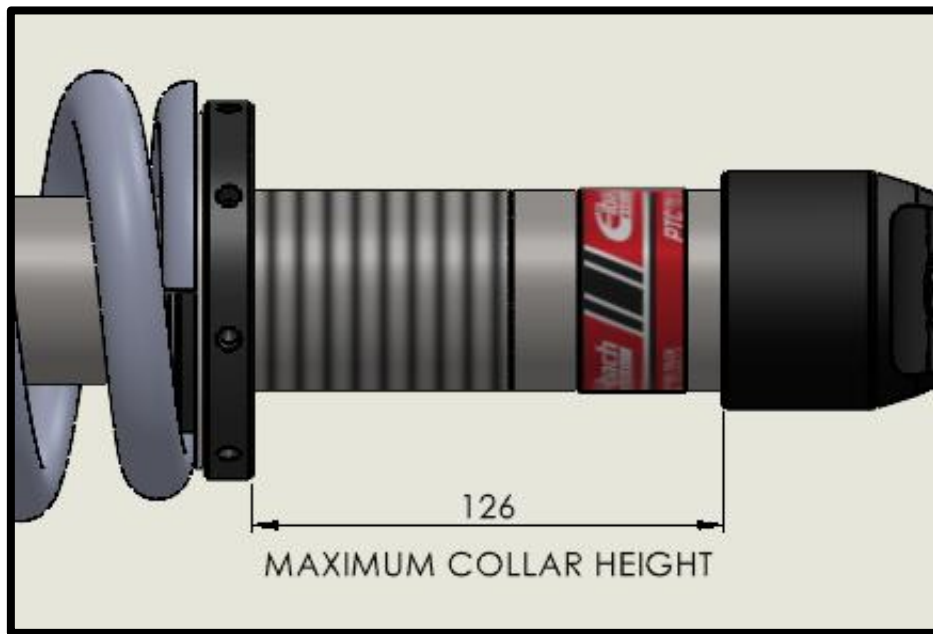

NOTE: DO NOT GO ABOVE A SPRING COLLAR HEIGHT OF 126mm FROM BOTTOM OF COLLAR TO BASE AS SHOWN. DOING SO WILL CAUSE DAMAGE TO THE SHOCK AND SUSPENSION.



Left Side



Right Side

Note: Orient both left and right shocks with the reservoir facing the rear of the vehicle as shown above.