



# INSTALLATION GUIDE

## 2021-UP/FORD F-150 RAPTOR

### ROCK FIGHTER FRONT BUMPER

F210185080103



#### TOOLS REQUIRED

(Sockets) 7/16, 9/16, 3/4, 8mm, 10mm, 13mm, 15mm, 21mm

(Box end wrenches) 7/16, 9/16, 3/4, 8mm, 10mm, 13mm, 15mm, 21mm

(Allen wrenches) 5/32, 7/32, 5/16

Fastener remover or flathead screwdriver

Zip ties

Ratchet



#### TIME REQUIRED

- 4 hours for OEM Removal/Bumper Install

-1 Additional Hour to Wire Lights

**\*\*Labor Rates are based on a vehicle with no pre-existing damage. Wiring labor is based on a standard wiring procedure with light switches installed in an easily accessible location. Custom light triggering or switch mounting location will result in a greater labor charge.\*\***



#### SKILL LEVEL

-Easy/Intermediate

**\*\*This installation requires 2 people for best results\*\***



#### INCLUDED IN KIT

12- 3/8-16 X 1" Button Head Bolt

2- 3/8-16 x 1" Carriage Bolt

14- 3/8-16" Nylon Lock Nut

2- 1/2-13 x 1 1/2" Button Head

14- 3/8" Flat Washer

2- 1/2" Flat Washer

4- 3/8" Fender Washer

2- 1/2-13" nylon lock nut

4- 3/8-16 x 1" Hex Head Bolt

4- 3/8-16" U-Nut

## ⚠️ WARNINGS/CAUTIONS BEFORE STARTING INSTALLATION ⚠️

#### -BEFORE YOU INSTALL THIS KIT-

Read and understand all instructions, warnings, cautions, & notes contained in this installation instruction guide. Consult your vehicle owner's manual for proper disconnection of electrical and lifting of vehicle if required for installation of this product.

This install may require some technical skills and knowledge of basic mechanical work. If you do not feel that you are capable of performing this install please take this product to a trained professional.

After reading this guide please contact us with any questions or concerns before installing product.  
Customer Service (480) 671-0820

Addictive desert designs is not responsible for any bodily injury or harm to you or your vehicle as a result of an improper install.

Proper installation of this kit required knowledge of the factory recommended procedures for removal and installation of original equipment components.

We recommend that the factory shop manual and any special tools needed to service your vehicle be on hand during the installation. Installation of this kit without proper knowledge of the factory recommended procedures may affect the performance of these components and the safety of the vehicle.

Inspect all contents of this package to make sure product is not damaged and all installation hardware has been included. If parts are missing from kit, please be prepared to provide the following information:

1. Name of purchase location
2. Bar Code on side of box
3. Date above bar code
4. Date inside box cover

**\*ALWAYS WEAR EYE PROTECTION WHEN OPERATING POWER TOOLS\***



# INSTALLATION GUIDE

## ROCK FIGHTER FRONT BUMPER 2021-UP/FORD F-150 RAPTOR

## REMOVAL

### □ STEP 1

Remove the 6x bolts to release the OEM skid plate using a (13mm socket).





# INSTALLATION GUIDE

## ROCK FIGHTER FRONT BUMPER 2021-UP/FORD F-150 RAPTOR

## REMOVAL

### □ STEP 2

Remove the skid plate spacer.



## ROCK FIGHTER FRONT BUMPER 2021-UP/FORD F-150 RAPTOR

## REMOVAL

### □ STEP 3

Remove the support brackets holding the bumper to the frame horns using a (8mm socket). (Repeat on other side)

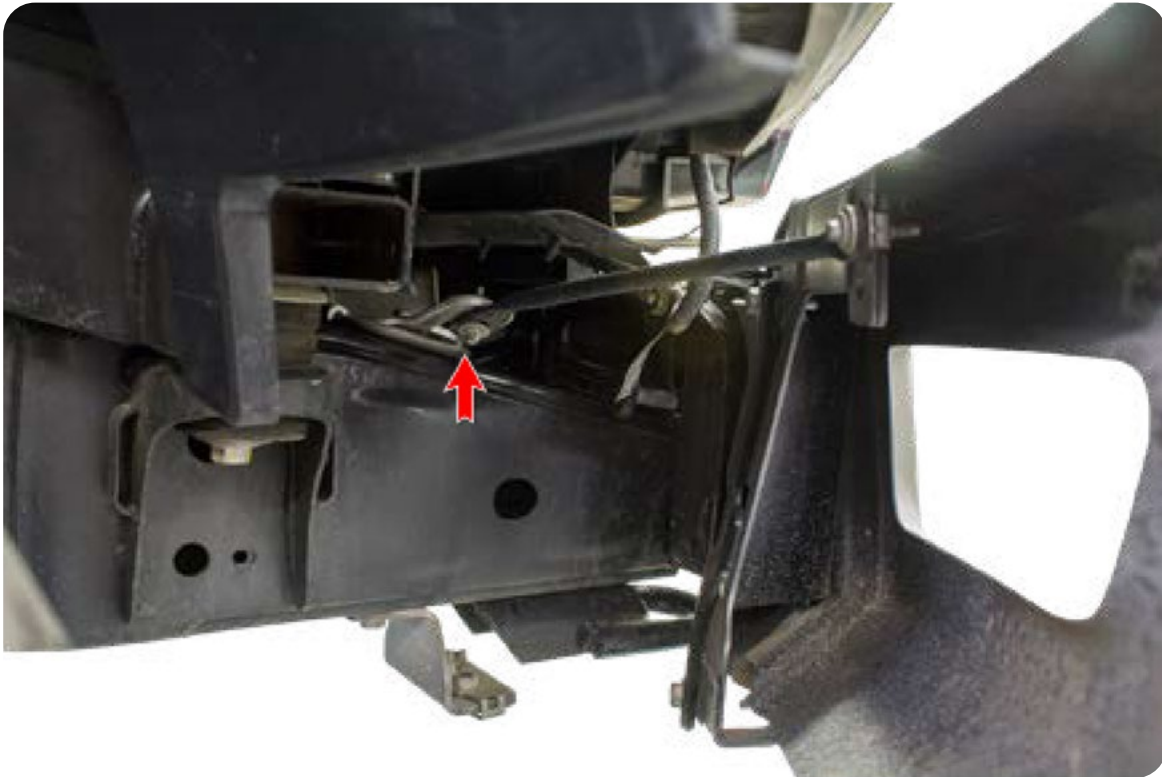

## ROCK FIGHTER FRONT BUMPER 2021-UP/FORD F-150 RAPTOR

## REMOVAL

### □ STEP 4

Unplug the main wiring harness plug in located on the passenger side by pulling the gray tab back as shown below.

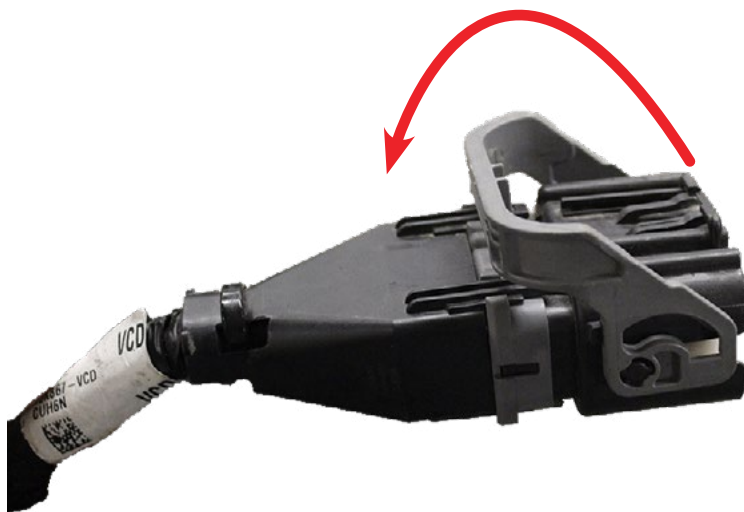
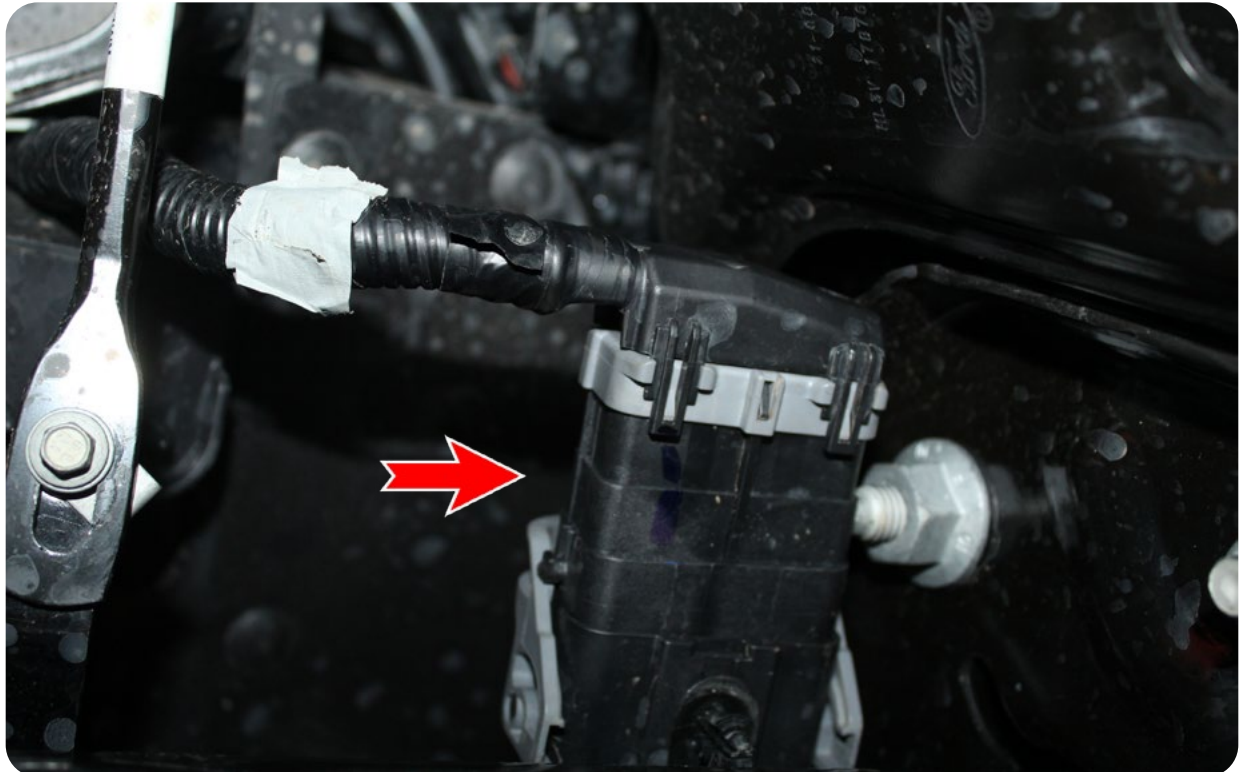

## ROCK FIGHTER FRONT BUMPER 2021-UP/FORD F-150 RAPTOR

## REMOVAL

### □ STEP 5

Remove the mounting bolts located on the frame horn using a (21mm Socket). (Repeat on other side)

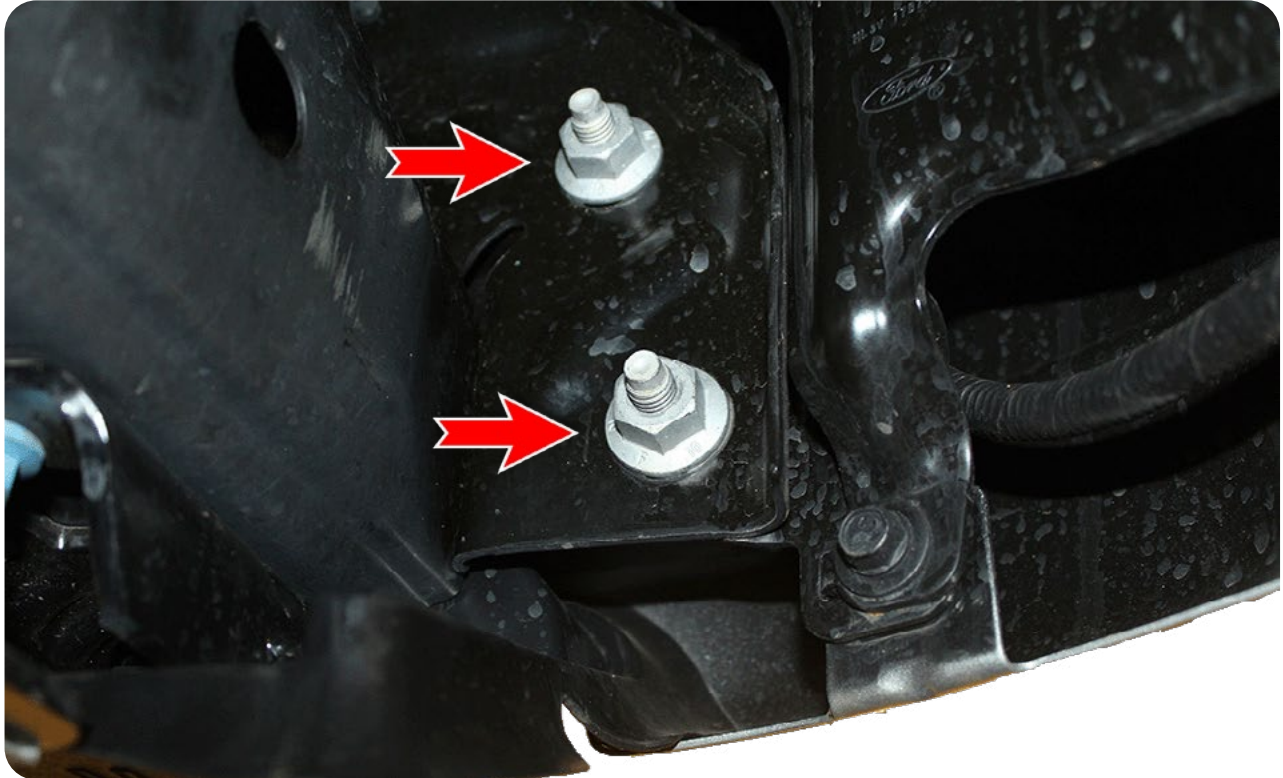

## ROCK FIGHTER FRONT BUMPER 2021-UP/FORD F-150 RAPTOR

## REMOVAL

### □ STEP 6

- Remove the inter cooler guard bolts by using a (10mm socket) and remove the shutter motor from the guard. Zip tie the shutter motor to the wiring harness once it is installed on your ADD bumper.
- If you have a **2024 F-150 Raptor**, Follow the install guide for the Shutter Motor Bracket.  
[https://www.addictivedesertdesigns.com/cdn/shop/files/ADD\\_InstallGuide\\_AC1300900NA.pdf?v=4894805209185784070](https://www.addictivedesertdesigns.com/cdn/shop/files/ADD_InstallGuide_AC1300900NA.pdf?v=4894805209185784070)



## ROCK FIGHTER FRONT BUMPER 2021-UP/FORD F-150 RAPTOR

## REMOVAL

### □ STEP 7

Remove the tow hooks and the skid plate mount by using a (15mm socket) and a (13mm socket).

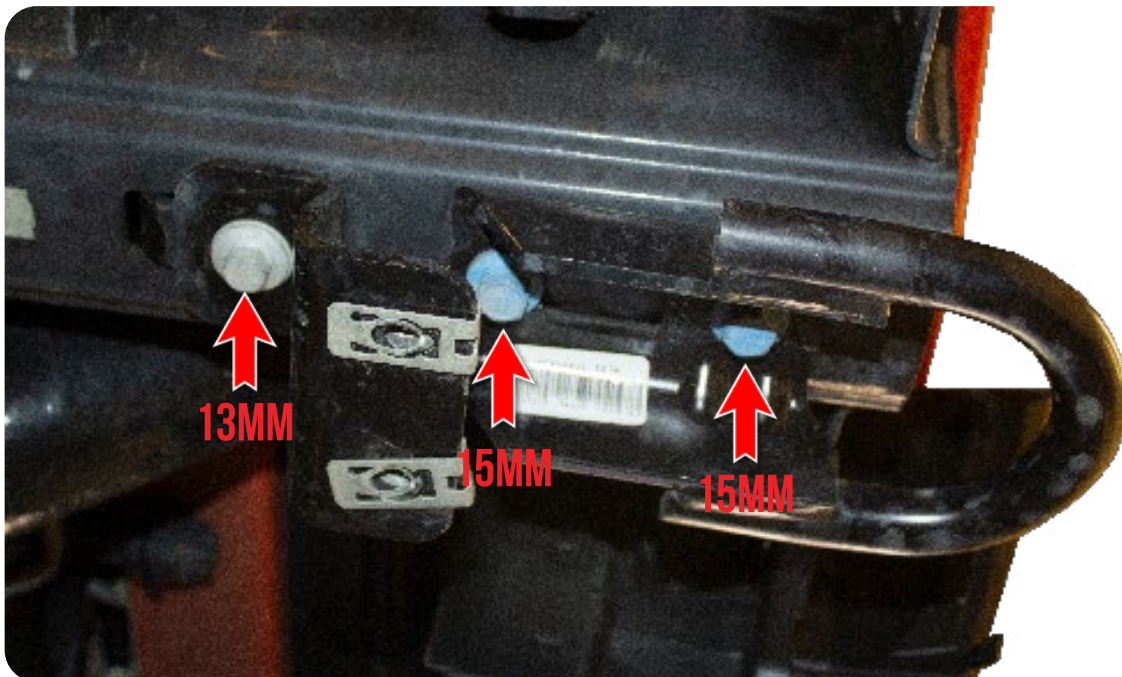
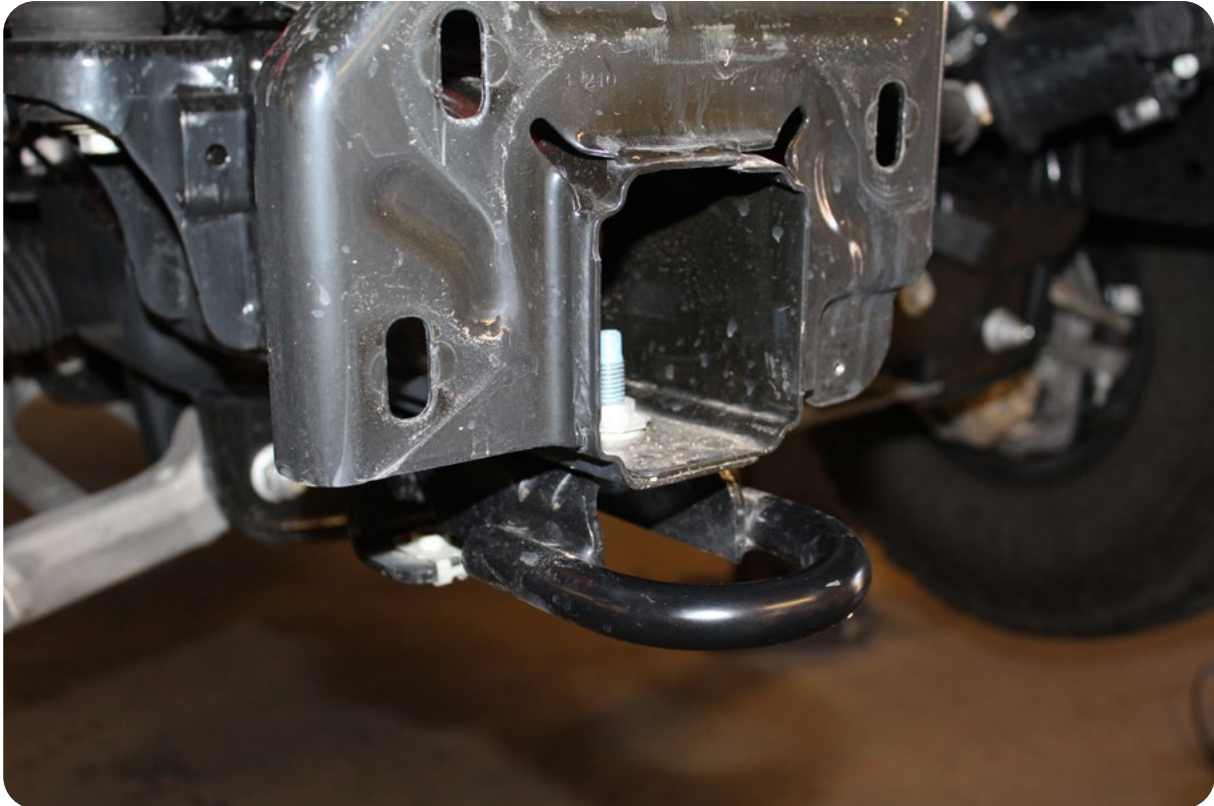

## ROCK FIGHTER FRONT BUMPER 2021-UP/FORD F-150 RAPTOR

## REMOVAL

### □ STEP 8

Remove the OEM nut clips for the skid plate bottom mounts and replace with the provided 3/8" nut clips.

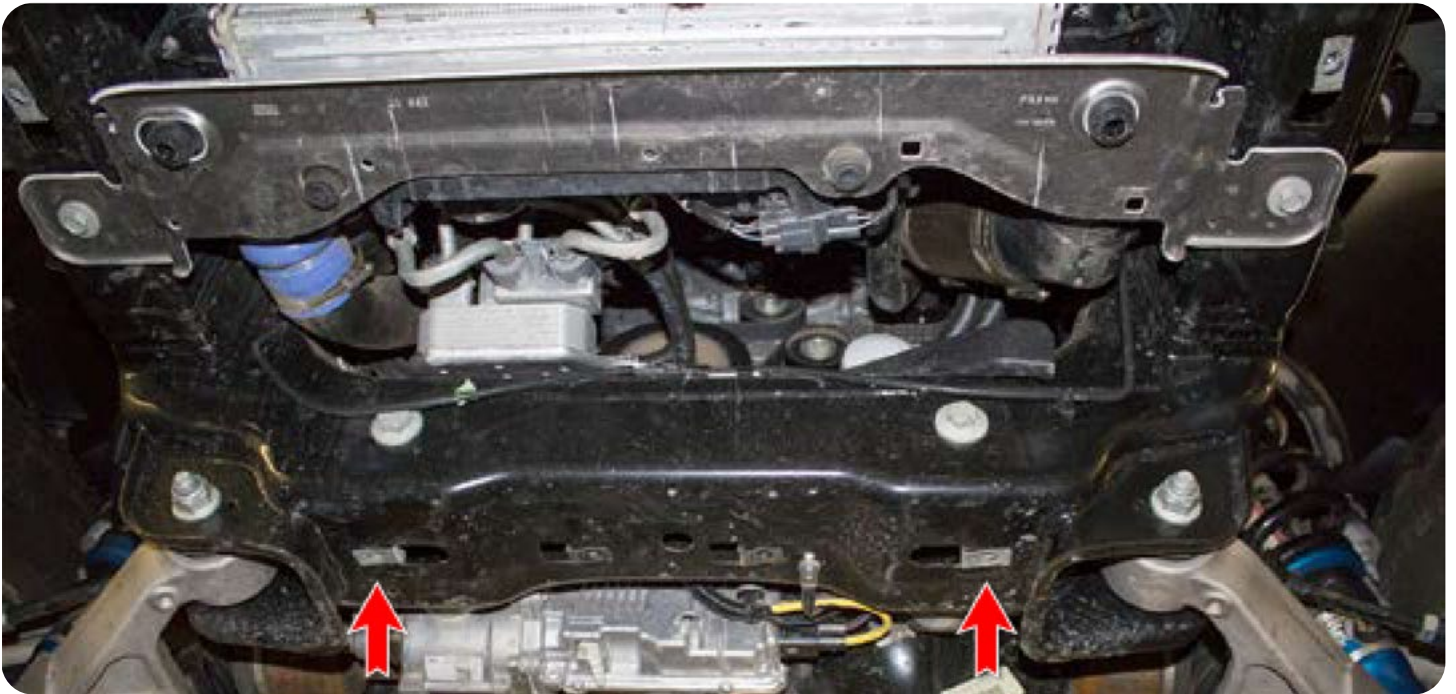

## ROCK FIGHTER FRONT BUMPER 2021-UP/FORD F-150 RAPTOR

## REMOVAL

### □ STEP 9

Using a (10mm socket), remove the covers to expose the wire harness.

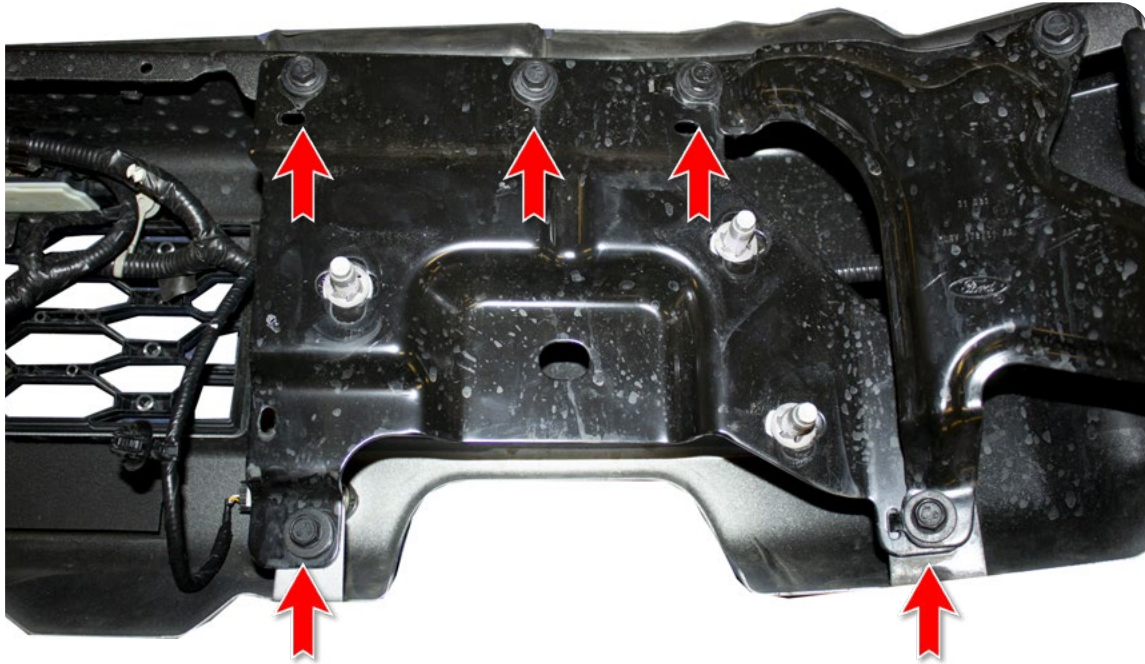



# INSTALLATION **GUIDE**

ROCK FIGHTER FRONT BUMPER  
2021-UP/FORD F-150 RAPTOR

## REMOVAL



## ROCK FIGHTER FRONT BUMPER 2021-UP/FORD F-150 RAPTOR

## REMOVAL

### STEP 10

Remove all four parking sensors and bezels from the stock bumper and remove wire harness.

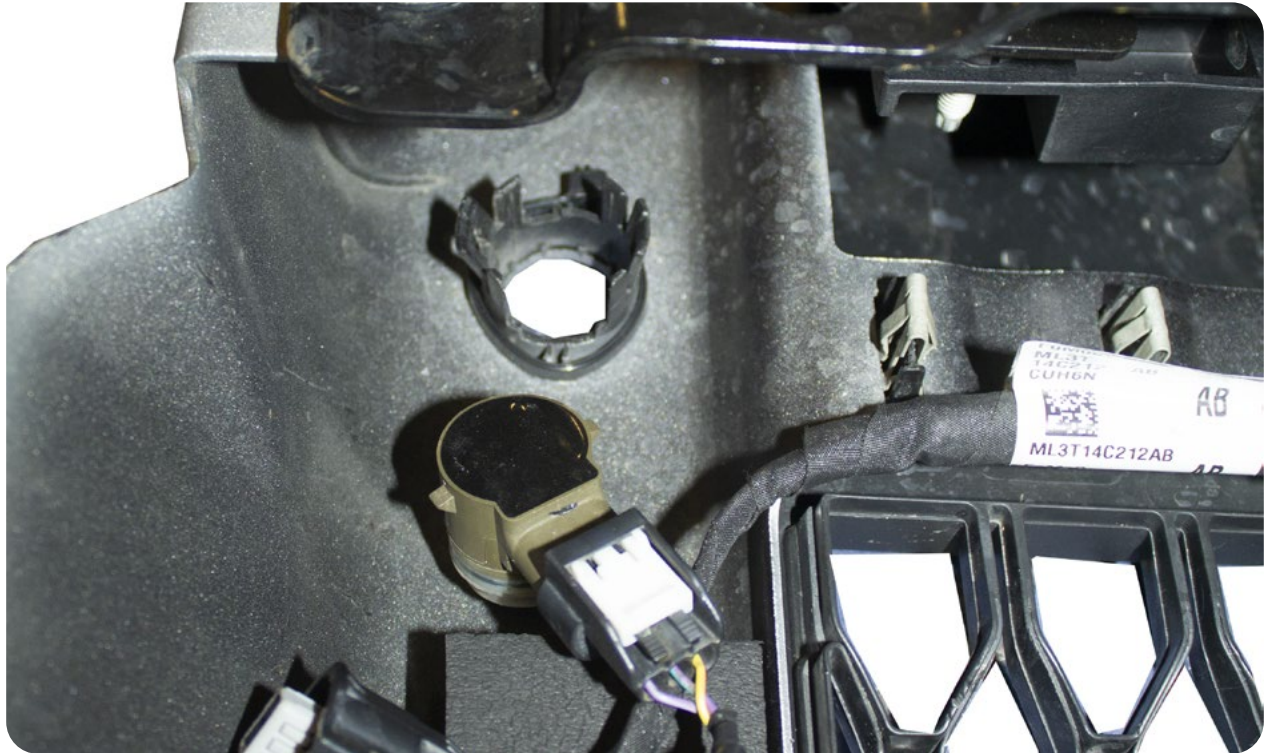

Spread these two tabs to release the sensor from its mounting ring.





# INSTALLATION GUIDE

## ROCK FIGHTER FRONT BUMPER 2021-UP/FORD F-150 RAPTOR

## INSTALL

### □ STEP 11

Install the sensor bezels into the ADD bumper. **\*\*If the bezels do not click into place you may have to trim the tabs to match the thickness of the bumper as shown below\*\***

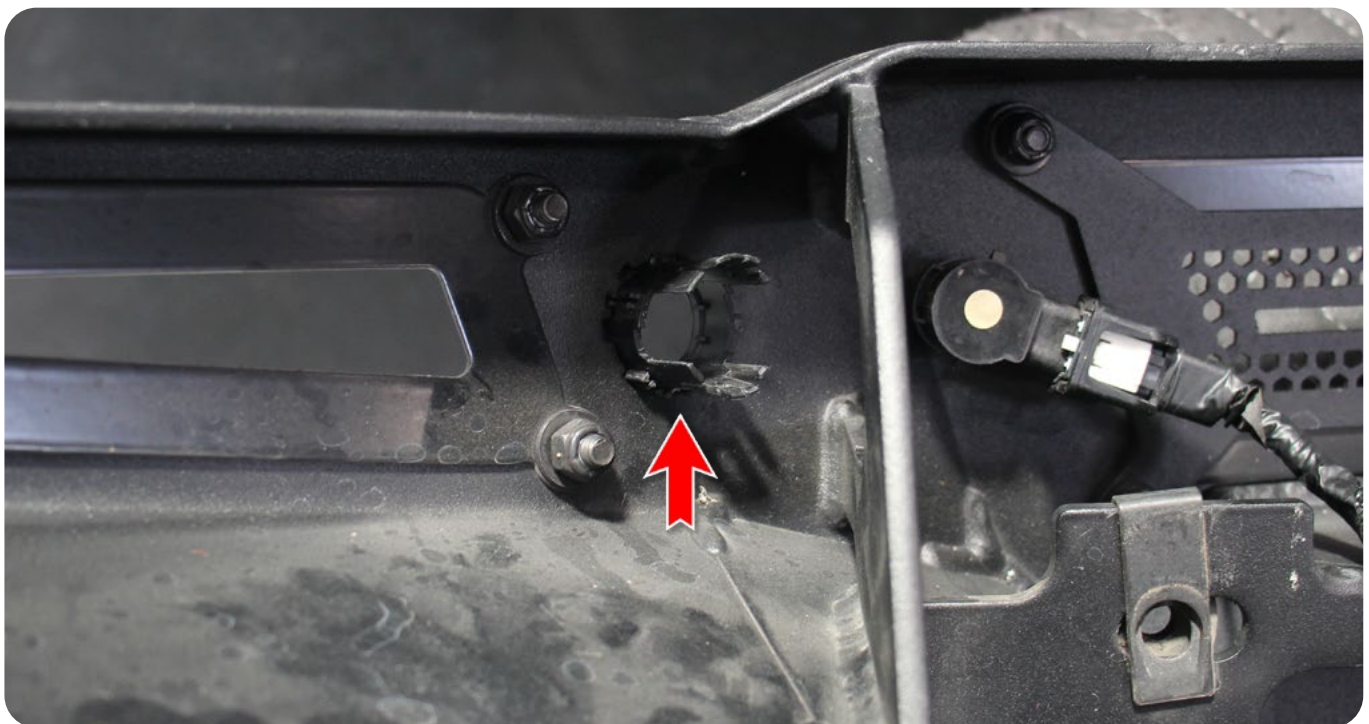
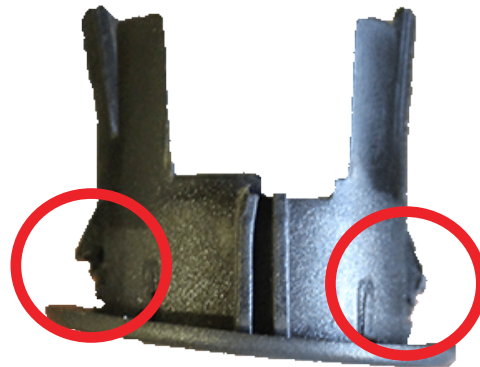
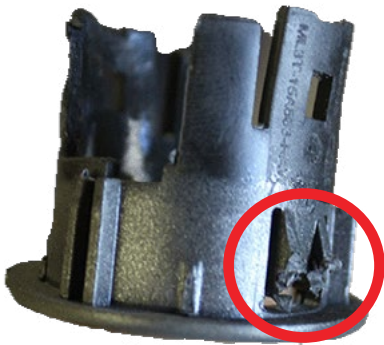



# INSTALLATION GUIDE

## ROCK FIGHTER FRONT BUMPER 2021-UP/FORD F-150 RAPTOR

## INSTALL

### □ STEP 12

Install the skid plate to the bumper with the provided (A, A1, A2) 3/8" hardware using a (7/32 allen wrench) and (9/16 wrench).

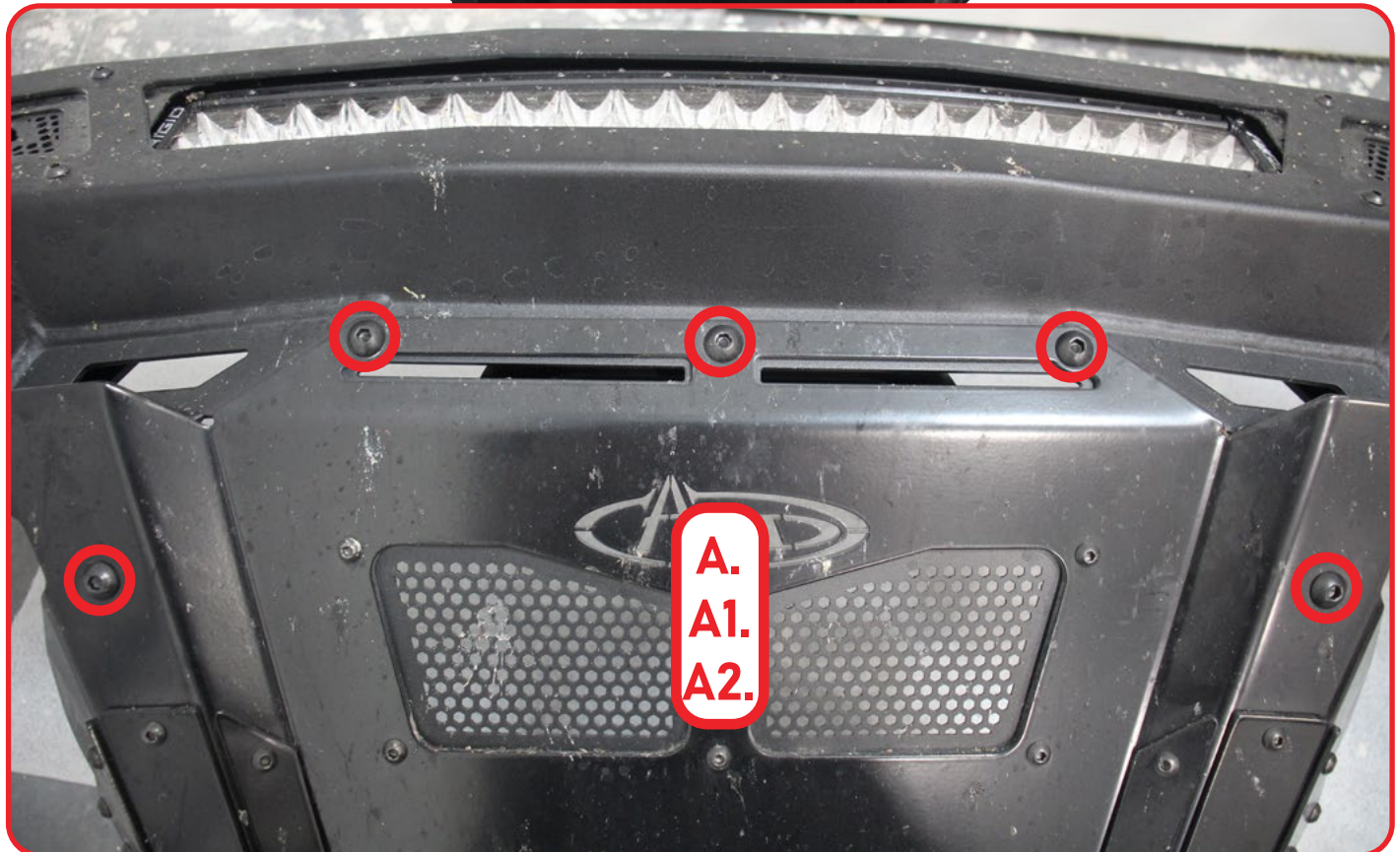



# INSTALLATION GUIDE

## ROCK FIGHTER FRONT BUMPER 2021-UP/FORD F-150 RAPTOR

## INSTALL

### □ STEP 13

Install the skid plate mount to the skid with the provided (A, A1, A2) 3/8" hardware using a (7/32 allen wrench) and (9/16 wrench).

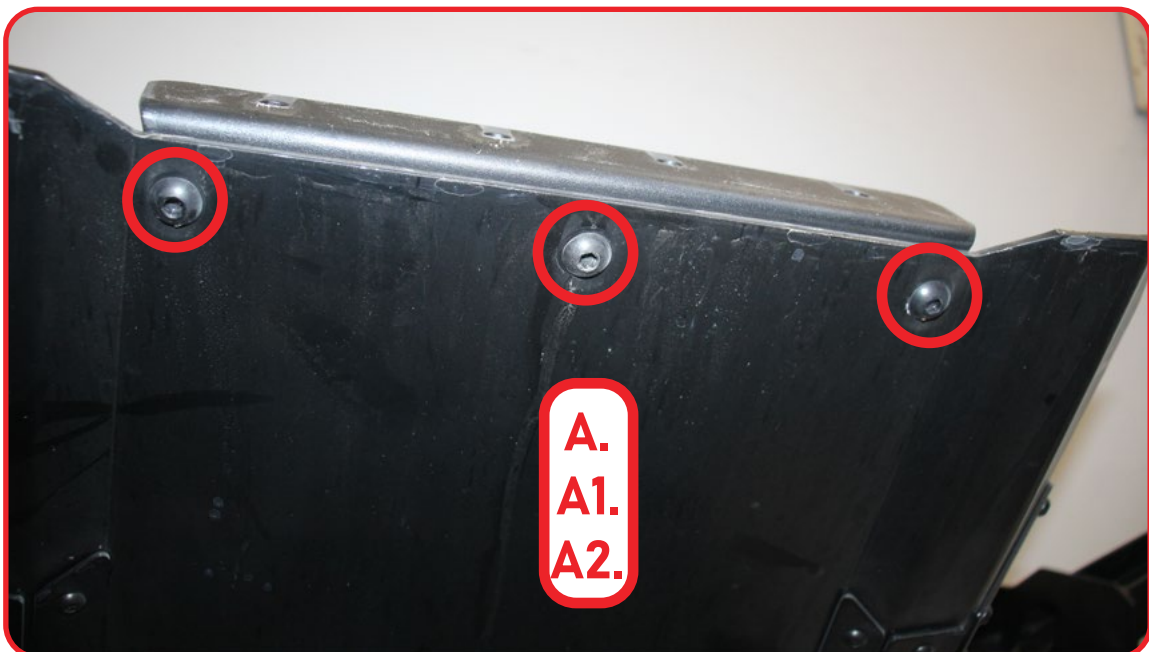
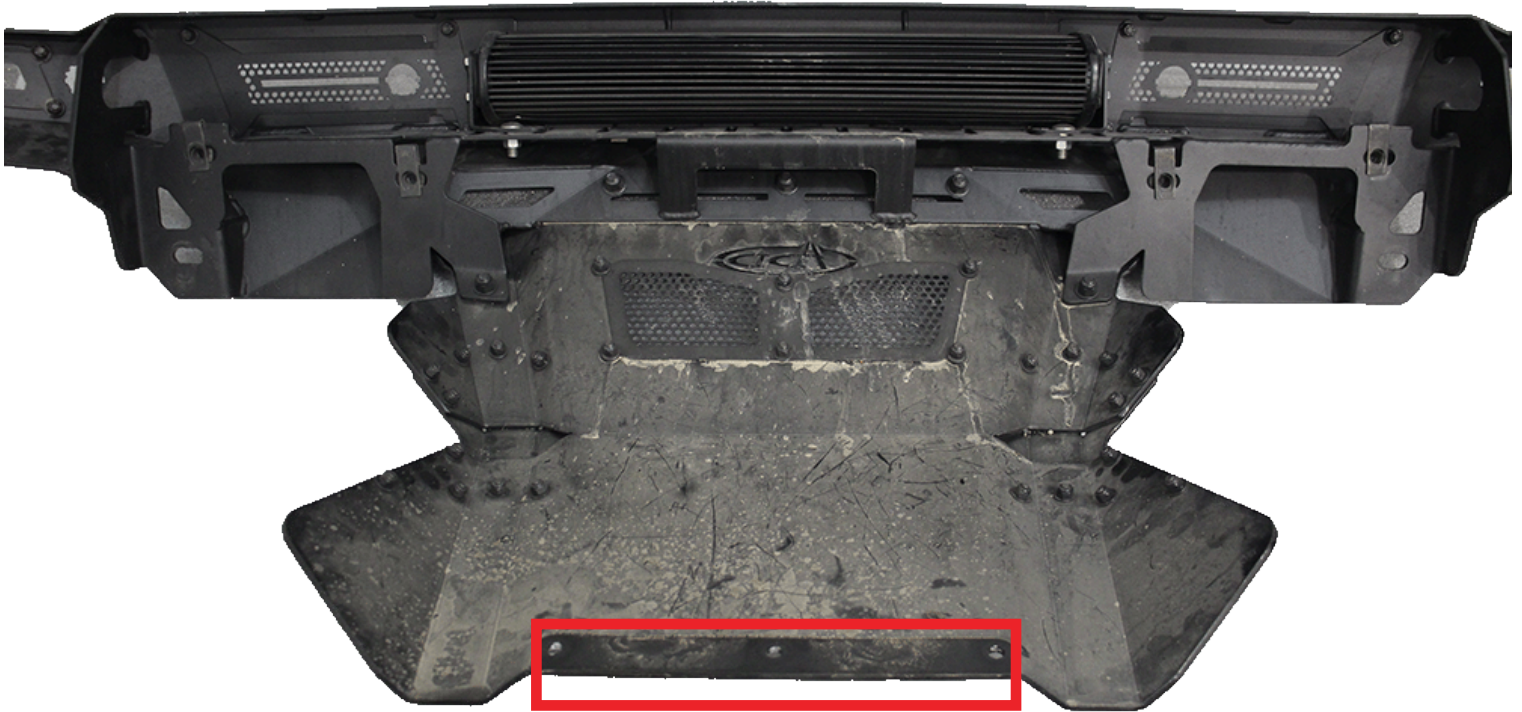



# INSTALLATION GUIDE

## ROCK FIGHTER FRONT BUMPER 2021-UP/FORD F-150 RAPTOR

## INSTALL

### □ STEP 14

Install the skid plate mount to the skid with the provided (A, A1, A2) 3/8" hardware using a (7/32 allen wrench) and (9/16 wrench).

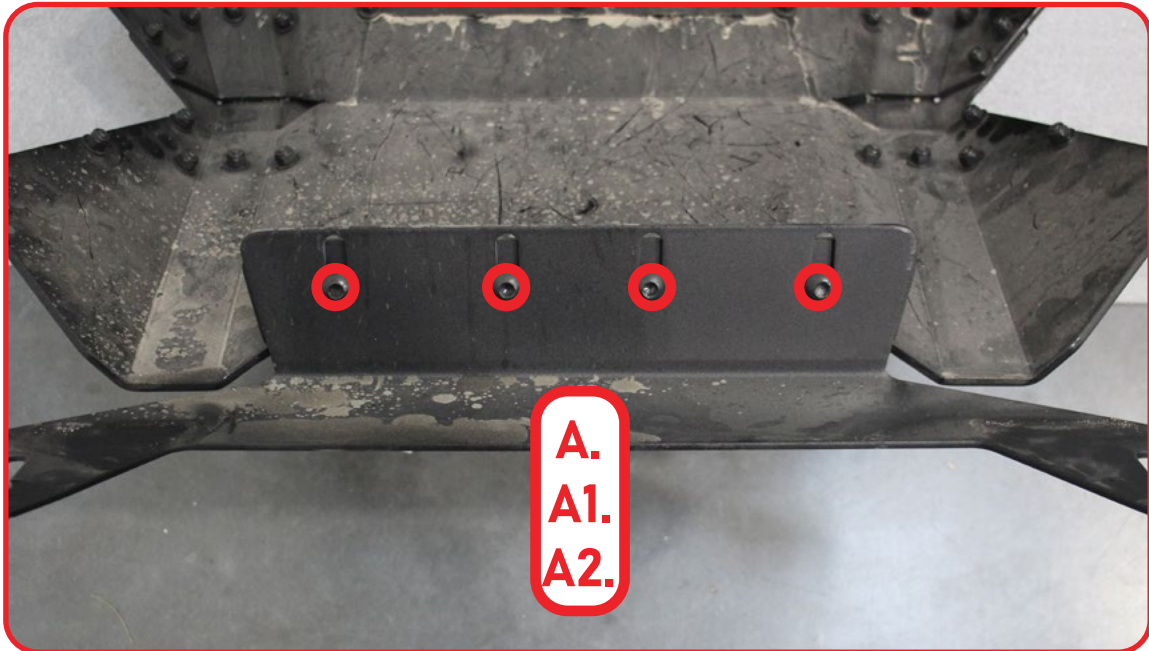
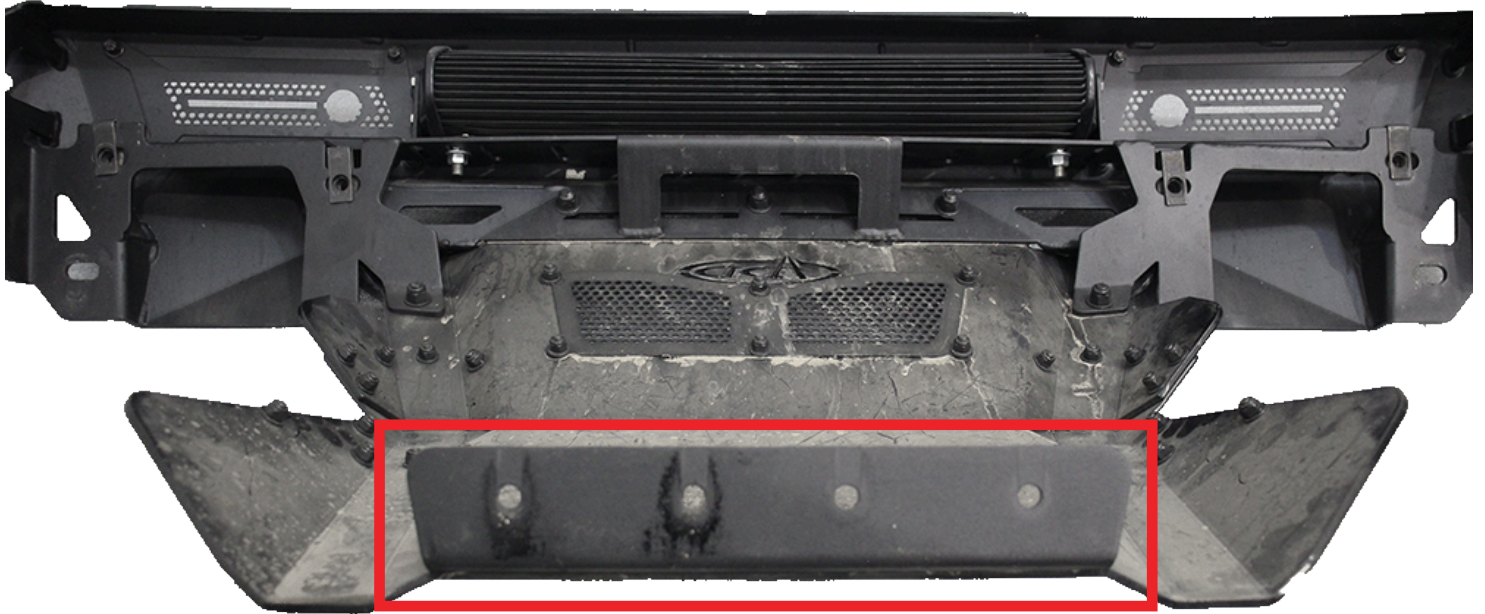

## ROCK FIGHTER FRONT BUMPER 2021-UP/FORD F-150 RAPTOR

## INSTALL

### □ STEP 15

Install the wiring harness and plug in the sensors into the bezels in the orientation shown below.

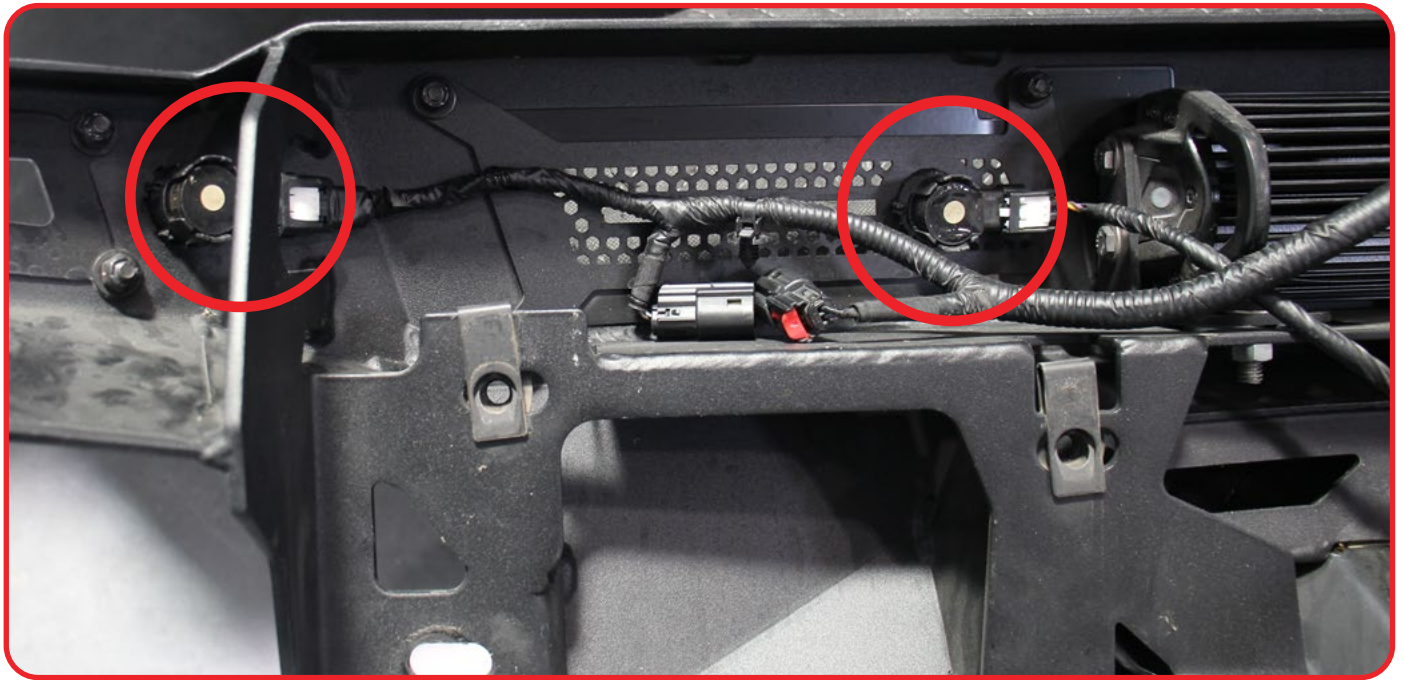
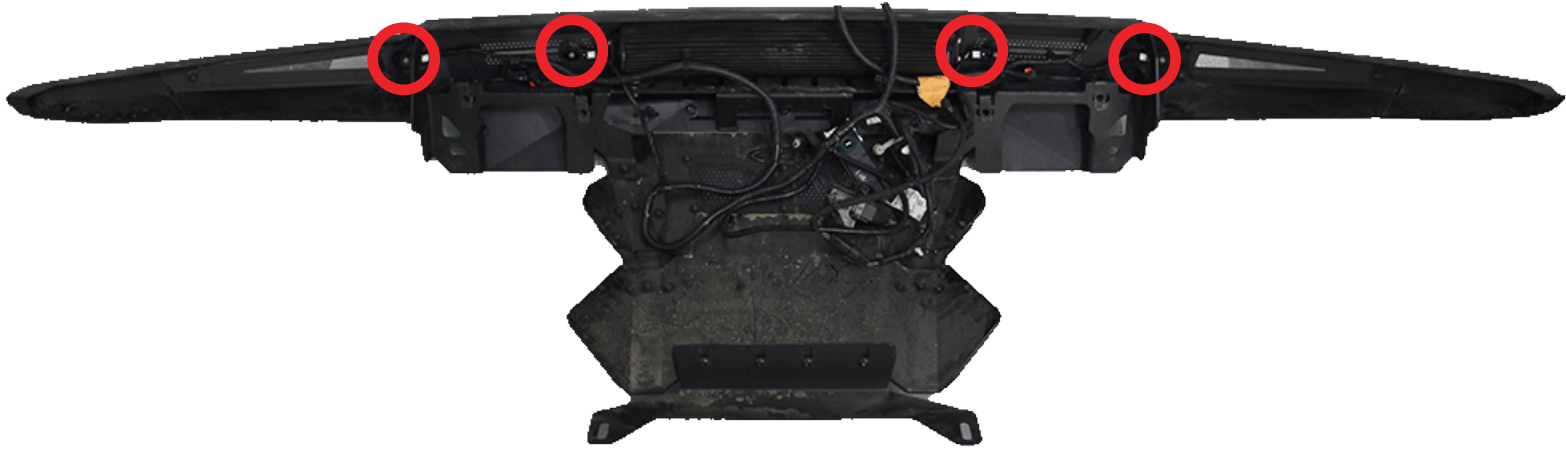

## ROCK FIGHTER FRONT BUMPER 2021-UP/FORD F-150 RAPTOR

## INSTALL

### STEP 16

Now would be a good time to install the light with the provided (A1, A2, C) 3/8" hardware and carriage bolt using a (9/16 wrench).

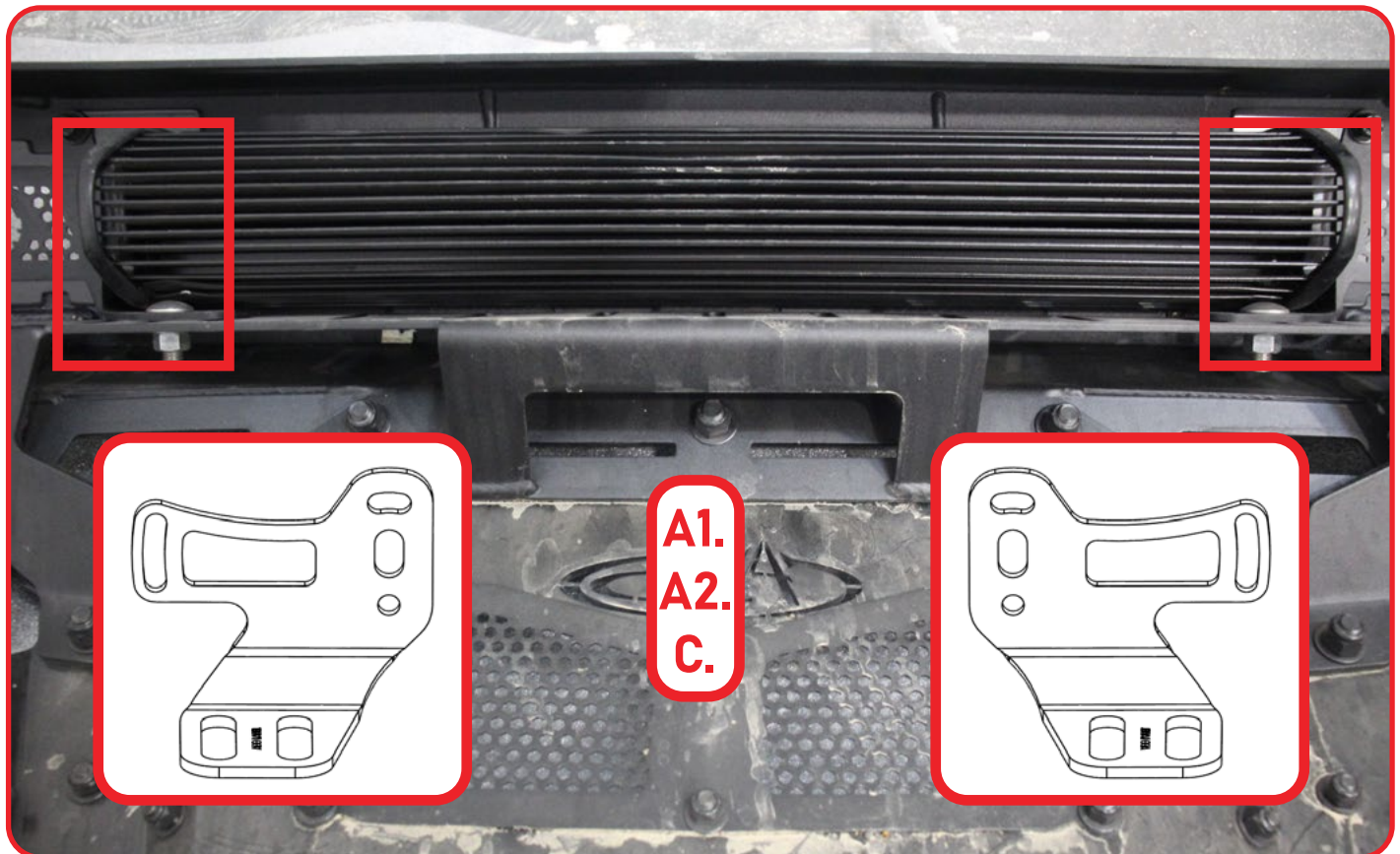
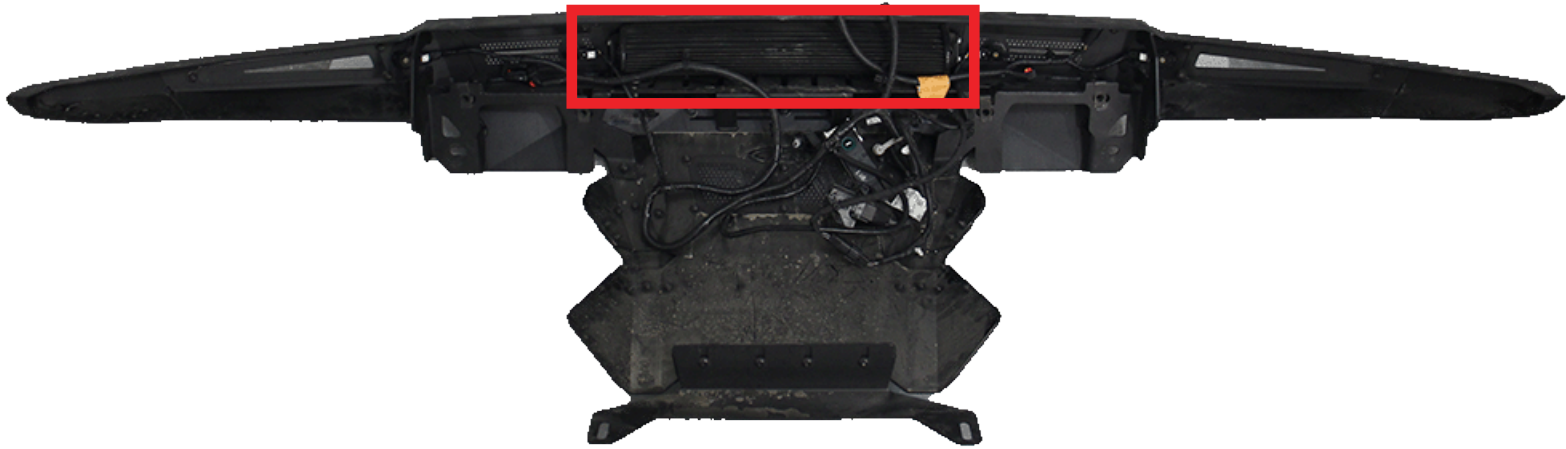



# INSTALLATION GUIDE

## ROCK FIGHTER FRONT BUMPER 2021-UP/FORD F-150 RAPTOR

## INSTALL

### □ STEP 17

Install the provided **(B2)** 3/8" U-Nut.

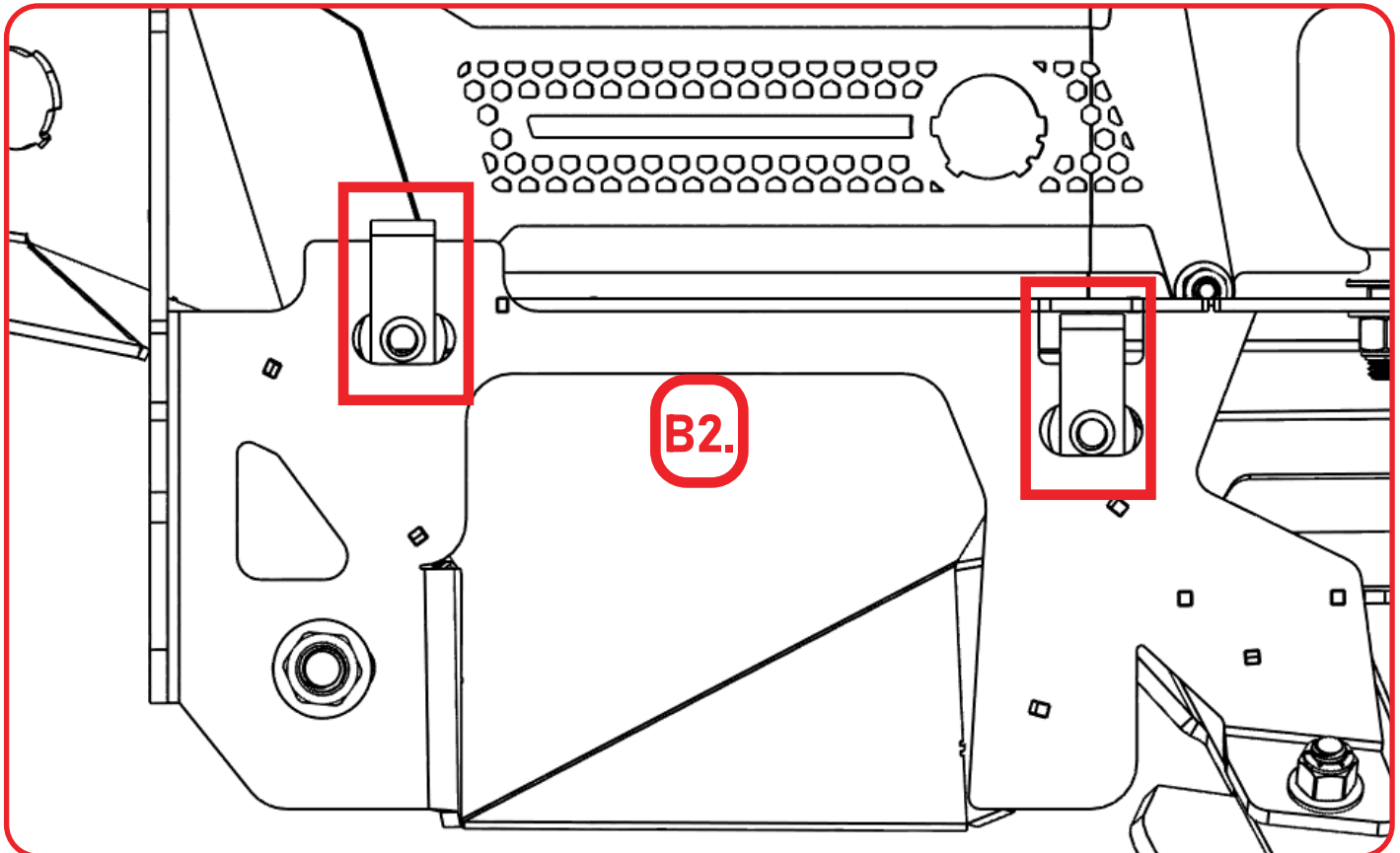
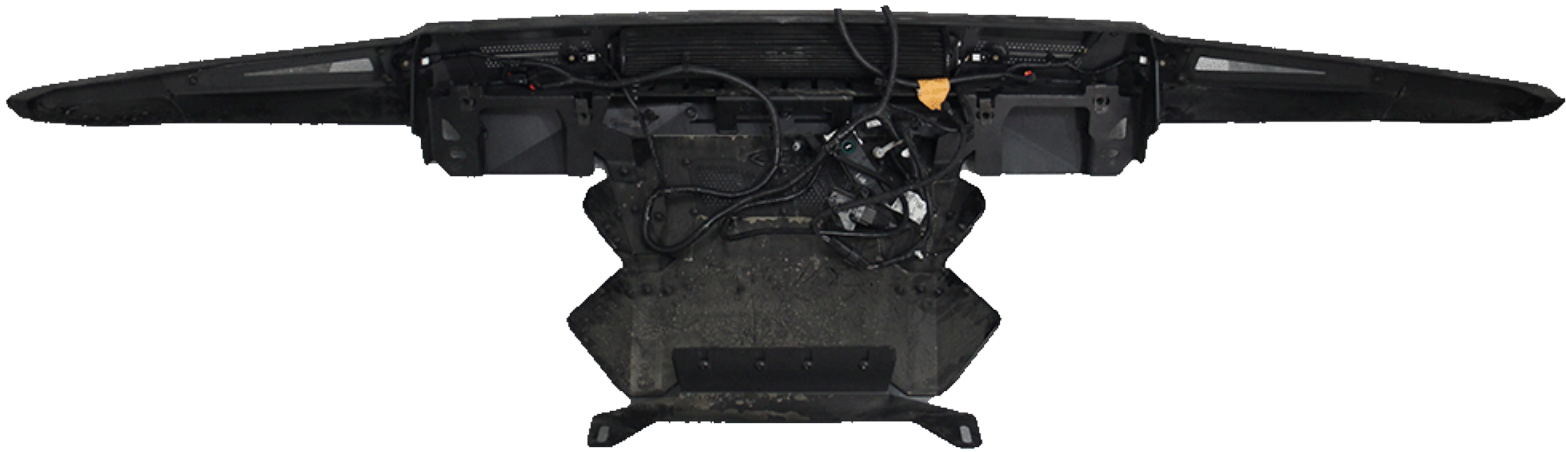



# INSTALLATION GUIDE

## ROCK FIGHTER FRONT BUMPER 2021-UP/FORD F-150 RAPTOR

## INSTALL

### □ STEP 18

With a helping hand, install the bumper with the provided **(B, B1)** 3/8" Hardware using a (9/16 socket).

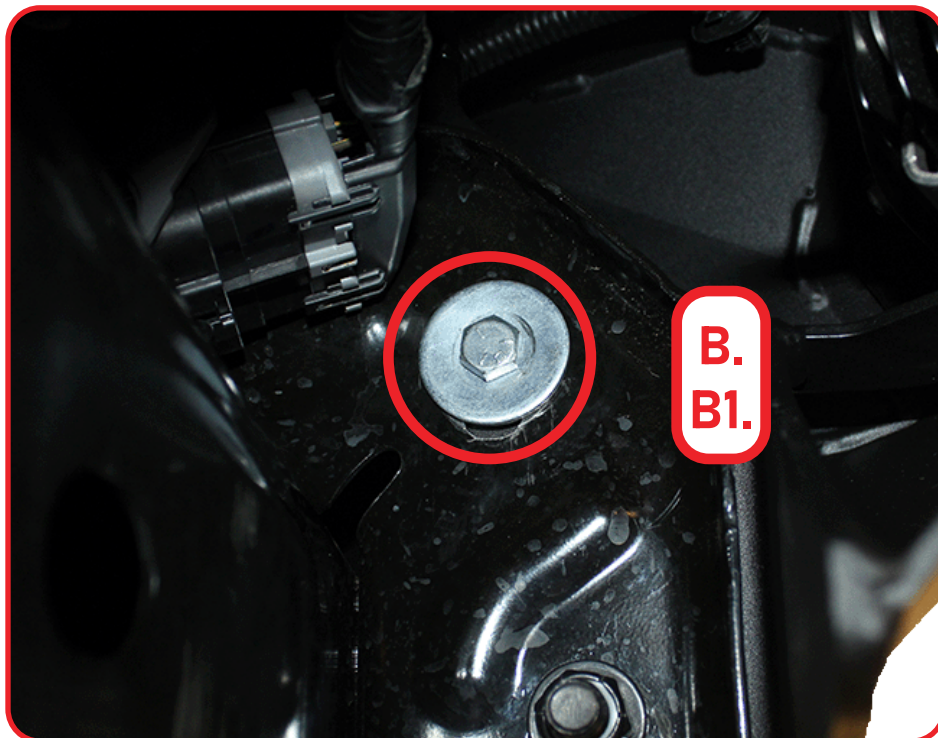



# INSTALLATION GUIDE

## ROCK FIGHTER FRONT BUMPER 2021-UP/FORD F-150 RAPTOR

## INSTALL

### □ STEP 19

Install the provided (D, D1, D2) 1/2" hardware using a (3/4" wrench) and a (5/16 allen).

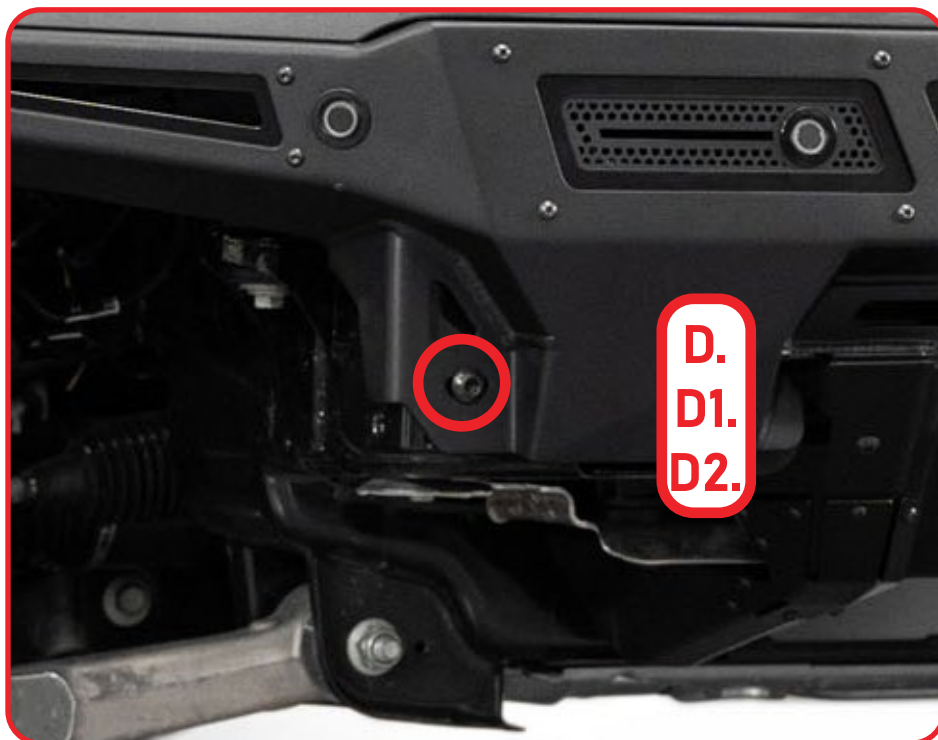

## ROCK FIGHTER FRONT BUMPER 2021-UP/FORD F-150 RAPTOR

## INSTALL

### □ STEP 20

Install the hardware removed from **step 1**. **\*\*Ensure the skid plate is installed underneath the rock guard as shown below\*\***

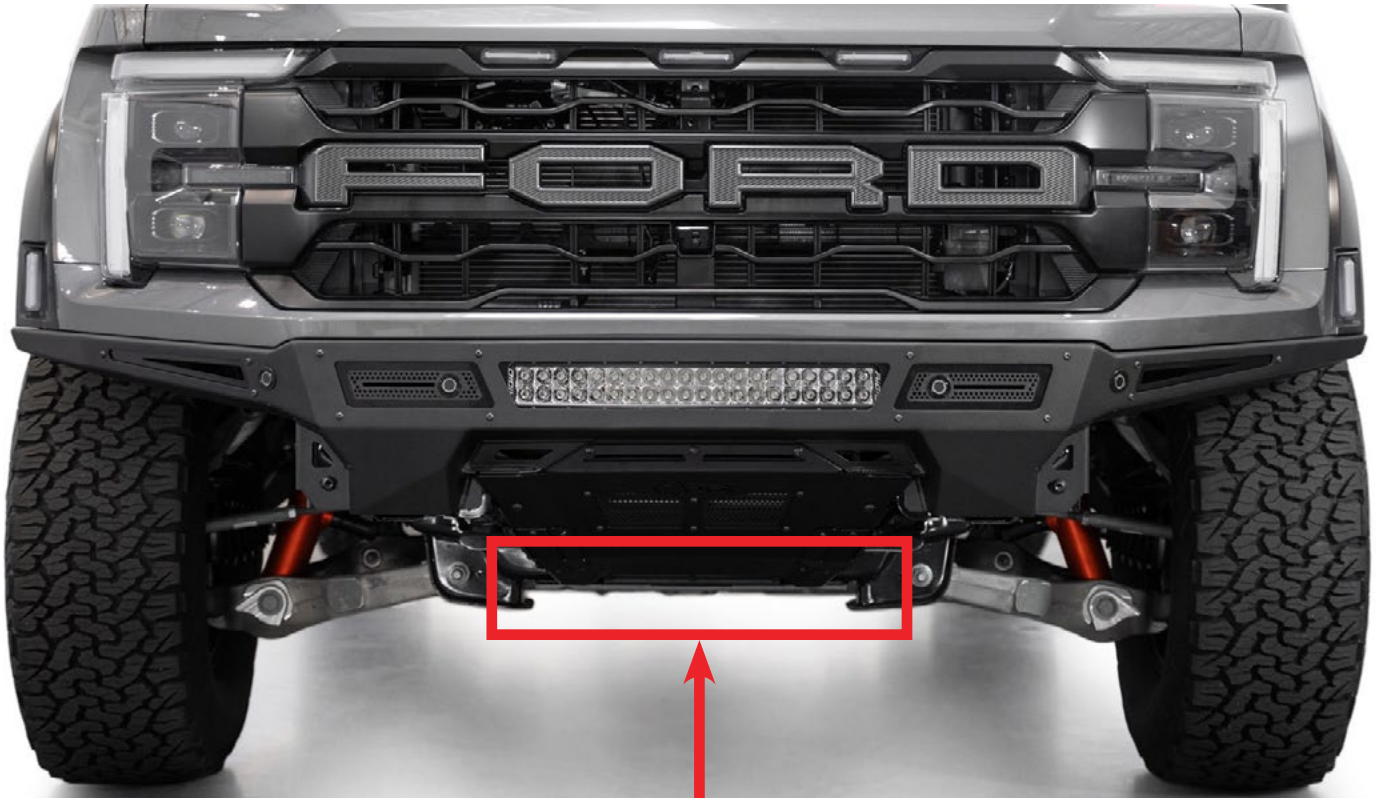

## ROCK FIGHTER FRONT BUMPER 2021-UP/FORD F-150 RAPTOR

## INSTALL

### □ STEP 21

Plug in the wire harness. **\*\*Ensure the clip is fully pushed down when plugged in as shown below\*\***

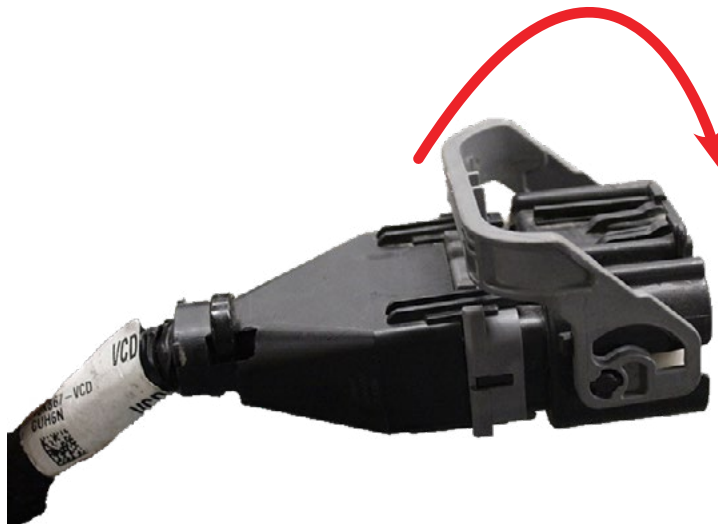
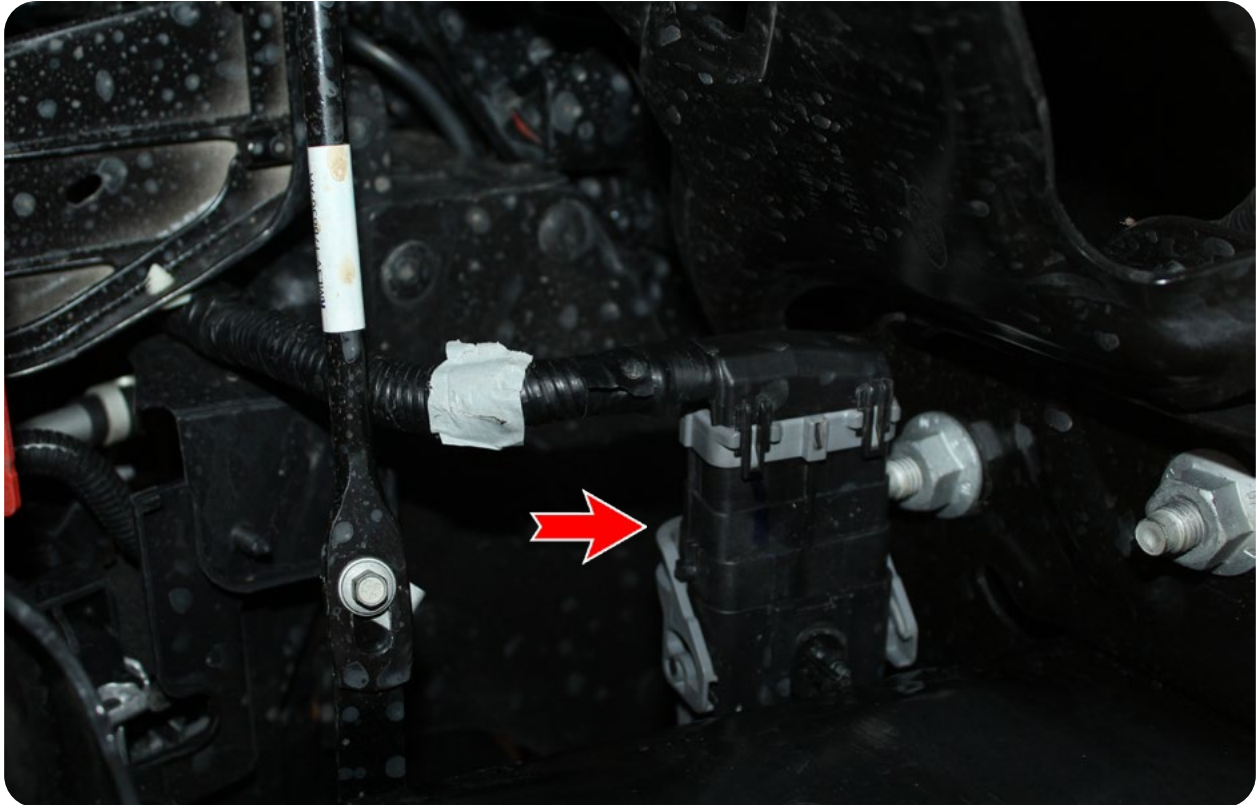



# INSTALLATION GUIDE

## ROCK FIGHTER FRONT BUMPER 2021-UP/FORD F-150 RAPTOR

## FINAL

### □ STEP 22

Stand back and enjoy your new ADD Rock Fighter Front Bumper.

Check and re-tighten, if needed, all mounting bolts after 100 miles and periodically thereafter.



THIS PRODUCT IS PROTECTED BY ONE OR MORE U.S. PATENTS  
[WWW.ADDICTIVEDESERTDESIGNS.COM/PATENTS](http://WWW.ADDICTIVEDESERTDESIGNS.COM/PATENTS)

FOR ADDITIONAL SUPPORT OR TECHNICAL QUESTIONS,  
PLEASE CALL 480-671-0820 OR  
EMAIL [INFO@ADDICTIVEDESERTDESIGNS.COM](mailto:INFO@ADDICTIVEDESERTDESIGNS.COM)