



INSTALLATION GUIDE

Inlet Pipe Upgrade Kit, Fits 2023+ Honda Civic Type R
SKU: MMAI-CTR-23U

TABLE OF CONTENTS

1. RESOURCES & CONTACT INFO
2. IMPORTANT SAFETY INFORMATION
INSTALL TIME & DIFFICULTY
REQUIRED TOOLS
5. DISPOSAL & WARRANTY INFORMATION

RESOURCES & CONTACT



CALL 1.877.466.4744

CUSTOMER SERVICE HOURS: MON-FRI 9:00AM-9:00PM ET



@MISHIMOTO



@GOMISHIMOTO



MISHIMOTO



@MISHIMOTO



ENGINEERING BLOG

WWW.MISHIMOTO.COM/ENGINEERING

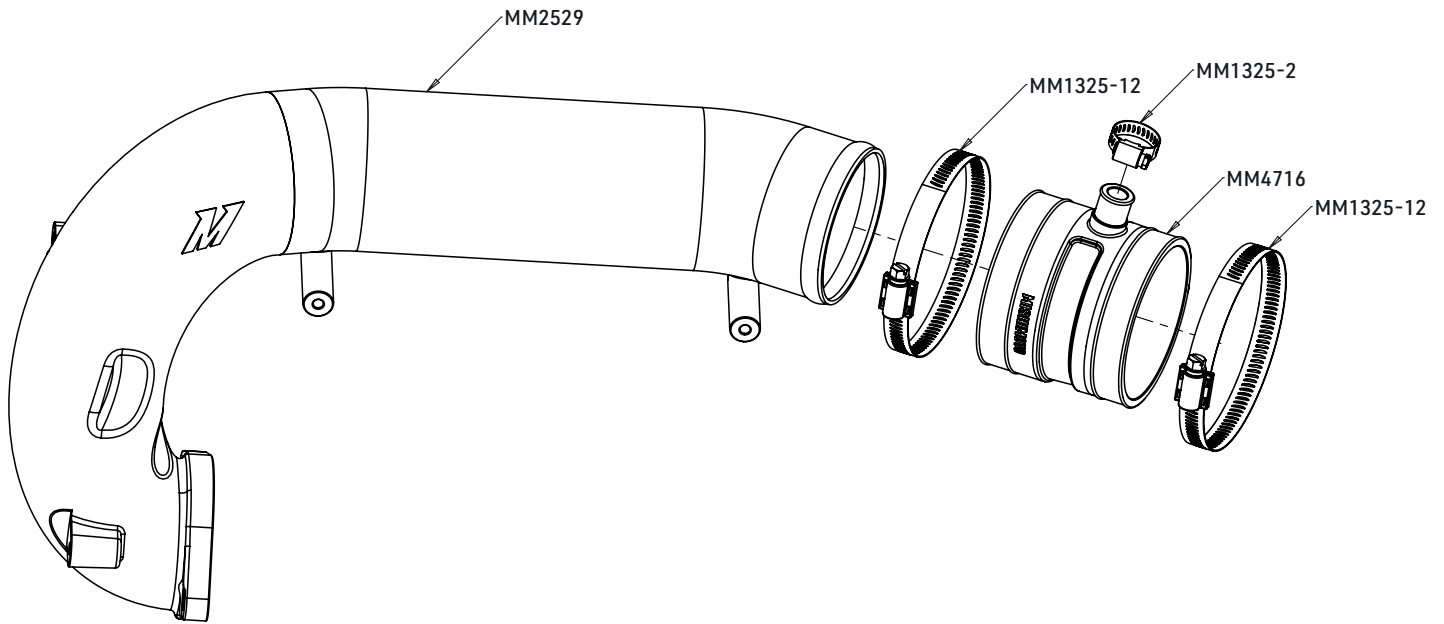

PARTS BREAKDOWN

PART NUMBER	DESCRIPTION	QTY
MM2529	INLET PIPE	1
MM4716	COUPLER	1
MM1325-2	12-20MM WORM GEAR CLAMP	1
MM1325	80-100MM WORM GEAR CLAMP	2

IMPORTANT SAFETY INFORMATION

- › Mishimoto recommends you use safety glasses and protective gloves during the installation of our products
- › Raise vehicle only on jack stands or on a vehicle lift
- › Allow vehicle to cool completely prior to attempting installation
- › Do not run the engine or drive the vehicle while overheating; serious damage can occur
- › Please dispose of any liquids properly
- › Mishimoto is not responsible for any vehicle damage or personal injury due to installation errors, misuse, or removal of Mishimoto products
- › If you need any assistance while installing our products, reach out to our Customer Service Team at 1.877.466.4744

REQUIRED TOOLS

1/4" RATCHET AND EXTENSION	10MM SOCKET
1/4" TORQUE WRENCH	12MM SOCKET
5.5MM SOCKET	VICE GRIPS
7MM SOCKET	

INSTALL TIME: 1 HOUR

INSTALL DIFFICULTY:     

INSTALLATION INSTRUCTIONS

1. Loosen the three clamps on the stock coupler.



2. The small clamp is a tamper-proof type that will require the use of pliers or vise grips to loosen. (Image on right)



3. Remove the 10mm bolt securing the turbo inlet pipe to the cylinder head.



4. Remove the two 10mm bolts securing the coolant pipe to the turbo inlet pipe.

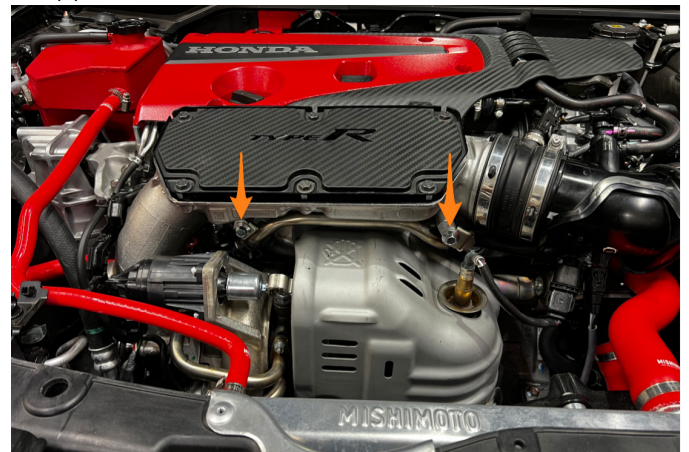

Continued on next page

5. Remove the two 10mm bolts securing the wire harness to the side of the turbo inlet pipe. (Image on following page)

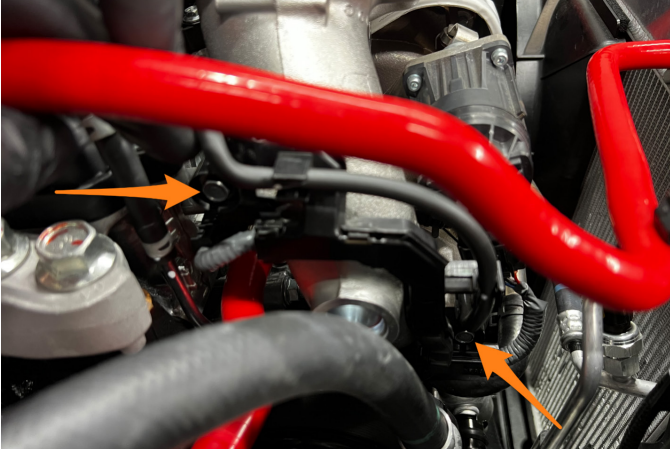

6. Remove the two 12mm bolts securing the turbo inlet pipe to the turbo.

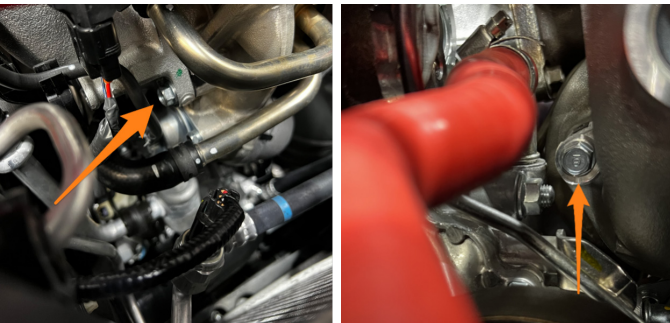

7. Remove the turbo inlet pipe from the vehicle.



8. Visually confirm that the turbo inlet gasket is still in place on the front of the turbo.



9. Transfer the mounting grommet from the stock turbo inlet pipe to the Mishimoto turbo inlet pipe.



Continued on next page

- 10.** Install the provided coupler onto the Mishimoto turbo inlet pipe using the provided clamps. Leave all the clamps loose.

Note the coupler orientation

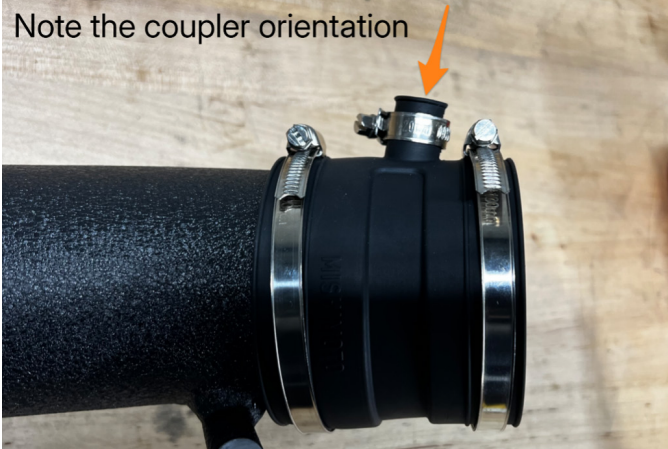

- 11.** Install the Mishimoto turbo inlet pipe into the vehicle.

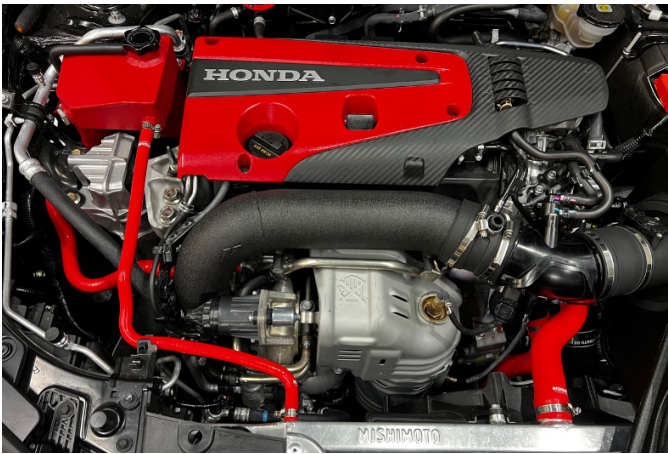

- 12.** Rotate the coupler until the small metal line can be inserted.



- 13.** Secure the Mishimoto turbo inlet pipe to the cylinder head using the previously removed 10mm bolt. Torque the bolt to 9.4 Nm (6.9 ft-lbs).



- 14.** Secure the Mishimoto turbo inlet pipe to the turbo using the previously removed 12mm bolts. Torque the bolts to 24 Nm (18 ft-lbs).

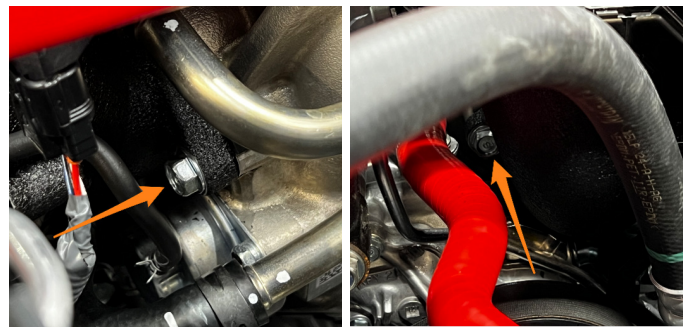

- 15.** Secure the wire harness to the side of the Mishimoto turbo inlet pipe using the previously removed 10mm bolts. Torque the bolts to 12 Nm (9 ft-lbs).

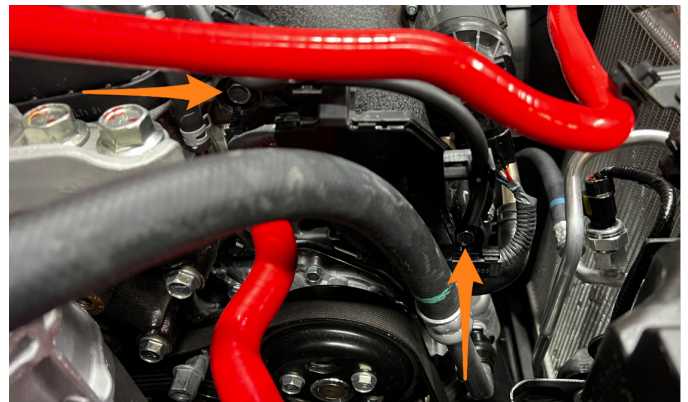

Continued on next page

16. Secure the coolant pipe to the Mishimoto turbo inlet pipe using the previously removed 10mm bolts. Torque the bolts to 12 Nm (9 ft-lbs).

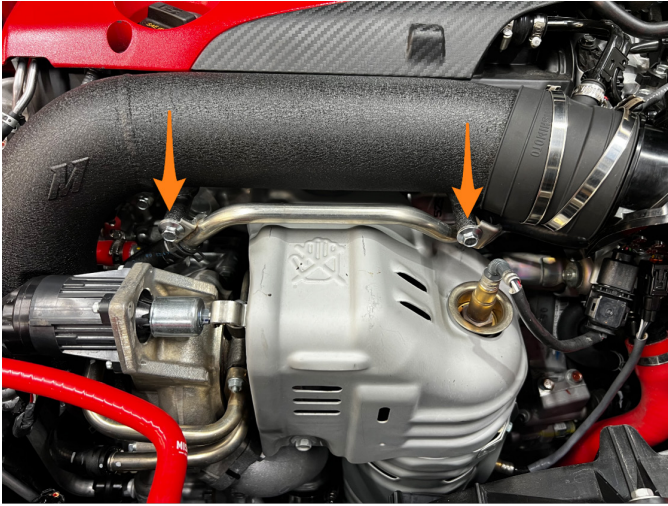

17. Tighten the three clamps.

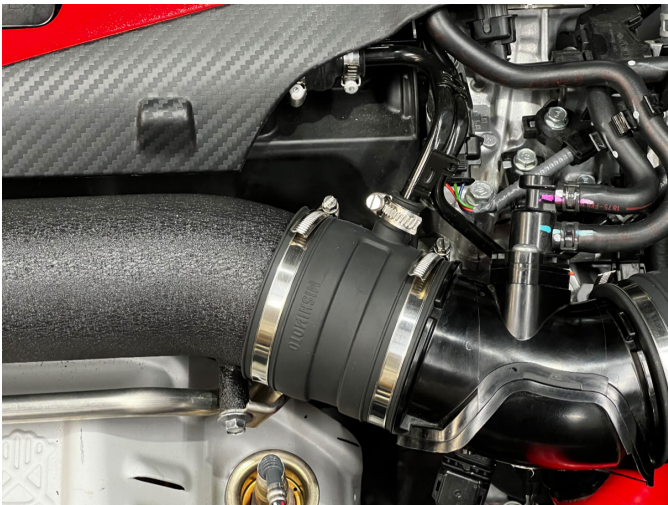

This concludes the install.

Continued on next page

DISPOSAL INSTRUCTIONS

- › Do not dispose of any product as unsorted municipal waste. Use separate collection facilities. Contact your local authority for information regarding the collection systems available.
- › Never improperly dispose of any coolant, oil, or other chemicals

WARRANTY INFORMATION



This product is backed by Mishimoto's Lifetime Limited Warranty. Please visit mishimoto.com/lifetime-warranty to see the full warranty.

ACTIVATE YOUR WARRANTY

Scan the QR code to activate your warranty. Every Mishimoto product is covered by our Mishimoto Lifetime Warranty, which also includes accident protection. Registration is easy. Visit: mishimoto.com/register and save the receipt for your records.



WARNING
Cancer and
Reproductive Harm
www.P65Warnings.ca.gov

- › This product can expose you to chemicals which are known to the state of California to cause cancer. For more information visit: www.p65warnings.ca.gov